

SEIKO

# ASTRON



GPS  
SOLAR



READ FIRST



CONTENTS

## Complete User Guide

8X82 GPS SOLAR WATCH (Chronograph)

**For proper and safe use of your SEIKO watch,  
please read carefully the instructions in this  
Complete User Guide before using it.**

- \* Length adjustment service for metallic bands is available at the retailer from whom the watch was purchased. If you cannot have your watch repaired by the retailer from whom the watch was purchased because you received the watch as a gift, or you moved to a distant place, please contact SEIKO WORLDWIDE SERVICE NETWORK. The service may also be available on a chargeable basis at other retailers, however, some retailers may not undertake the service.
- \* If your watch has a protective film for preventing scratches, make sure to peel it off before using the watch. If the watch is used with the film on it, dirt, sweat, dust, or moisture may be attached under the film and may cause rust.

## HANDLING CAUTIONS

### WARNING

To indicate the risks of serious consequences such as severe injuries unless the following safety regulations are strictly observed.

#### • Immediately stop wearing the watch in the following cases.

- If the watch body or band becomes edged by corrosion etc.
- If the pins protrude from the band.
- \* Immediately consult the retailer from whom the watch was purchased or SEIKO WORLDWIDE SERVICE NETWORK.

#### • Keep the watch and accessories out of the reach of babies and children.

Care should be taken to prevent a baby or a child accidentally swallowing the accessories.

If a baby or child swallows the battery or accessories, immediately consult a doctor, as it will be harmful to the health of the baby or child.

#### • Do not remove the secondary battery from the watch.

\* About the secondary battery → Power Source [P. 42](#)

Replacement of the secondary battery requires professional knowledge and skill. Please ask the retailer from whom the watch was purchased for replacement of the secondary battery.

Installation of an ordinary silver oxide battery can generate heat that can cause bursting and ignition.

### CAUTIONS

To indicate the risks of light injuries or material damages unless the following safety regulations are strictly observed.

#### • Avoid wearing or storing the watch in the following places.

- Places where volatile agents (cosmetics such as polish remover, bug repellent, thinners etc.) are vaporizing
- Places where the temperature drops below 5 °C or rises above 35 °C for a long time (41 °F and 95 °F)
- Places of high humidity
- Places affected by strong magnetism or static electricity
- Dusty places
- Places affected by strong vibrations

#### • If you observe any allergic symptoms or skin irritation

Stop wearing the watch immediately and consult a specialist such as a dermatologist or an allergist.

#### • Other cautions

- Replacement of the metal band requires professional knowledge and skill. Please ask the retailer from whom the watch was purchased for replacement of the metal band, as there is a risk of hand or finger injury and fear of losing parts.
- Do not disassemble or tamper with the watch.
- Keep the watch out of the reach of babies and children. Extra care should be taken to avoid risks of any injury or allergic rash or itching that may be caused when they touch the watch.
- When disposing of used batteries, follow the instructions of your local authorities.
- If your watch is of the fob or pendant type, the strap or chain attached to the watch may damage your clothes, or injure the hand, neck, or other parts of your body.
- Please keep in mind that if a watch is taken off and placed down as it is, the case back, the band and the clasp will rub against each other possibly causing scratches on the case back. We recommend placing a soft cloth between the case back, the band and the clasp after taking off your watch.

**⚠ WARNING****Do not use the watch for scuba diving or saturation diving.**

The various tightened inspections under simulated harsh environment, which are usually required for watches designed for scuba diving or saturation diving, have not been conducted on the water-resistant watch with the BAR (barometric pressure) display. For diving, use special watches specifically for diving.

**⚠ CAUTIONS****Do not pour running water directly from faucet.**

The water pressure of tap water from a faucet is high enough to degrade the water resistant performance of a water resistant watch for everyday life.

**⚠ CAUTIONS****Do not turn or pull out the crown when the watch is wet.**

Water may get inside of the watch.

\* If the inner surface of the glass is clouded with condensation or water droplets appear inside of the watch for a long time, the water resistant performance of the watch is deteriorated. Immediately consult the retailer from whom the watch was purchased or SEIKO WORLDWIDE SERVICE NETWORK.

**Do not leave moisture, sweat and dirt on the watch for a long time.**

Be aware of a risk that a water resistant watch may lessen its water resistant performance because of deterioration of the adhesive on the glass or gasket, or the development of rust on stainless steel.

**Do not wear the watch while taking a bath or a sauna.**

Steam, soap or some components of a hot spring may accelerate the deterioration of water resistant performance of the watch.



## Features

### □ This is a **GPS solar watch**.

This watch has the following features.

#### GPS signal reception

**This watch can be set to the precise local time by just one button operation\* anywhere in the world.**

\* DST (Daylight Saving Time) can be set manually.

This watch quickly adjusts the time by receiving GPS signals from GPS satellites.

→ **Place where GPS signals can be easily received/ cannot be received P. 16**

This watch responds to a total of 40 time zones around the world

→ **Time Zone P. 6**

When the region or time zone where the watch is used is changed, please carry out operation of "time zone adjustment."

→ **How to adjust the time zone P. 18**

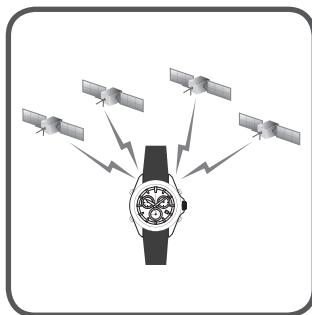

#### Solar charging Function

**This watch operates by solar charging.**

Expose the dial to light to charge the watch.

Once fully charged, the watch runs for approximately 6 months.

When the energy stored in the watch runs out completely, it takes time to fully charge the watch, so please keep in mind to charge the watch regularly.

→ **How to charge the watch P. 14**

→ **Standard charging time P. 14**



#### Automatic time adjustment function

**This watch automatically adjusts the time in accordance with action patterns during use.**

When the watch has sensed sufficient brightness under an open sky, it automatically receives GPS signals from GPS satellites. This function enables the watch to automatically adjust the time precisely even while you are using the watch.

→ **Automatic time adjustment P. 25**

\* This watch is unable to receive GPS signals when the energy stored in the watch is low.

→ **Check the Charging Status P. 13**



\* Unlike navigation equipment, this GPS solar watch is not designed to constantly receive GPS signals from GPS satellites without any operation. This watch receives GPS signals only in the time zone adjustment mode, automatic or manual time adjustment mode.

## Mechanism by which the GPS solar watch sets time and date

### What GPS is

GPS stands for Global Positioning System, a satellite positioning system for determining the current position on the earth.

24 satellites cover the earth, and at present, the system is operated by approximately 30 GPS satellites.

Wherever you are in the world, the position can be determined (positioned) by information from more than 4 GPS satellites.

### GPS satellite

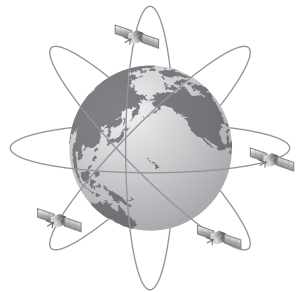

This is a satellite operated by the United States Department of Defense (official name is NAVSTAR), and orbits the earth at an altitude of 20,000 km. Initially, this was a military satellite, but at present, information is partially disclosed to the public and used in various equipment including car navigation systems and cellular phones.

The GPS satellite is mounted with a high-accuracy atomic clock with an accuracy deviation of 1 second per 100,000 years.

### Mechanism by which this watch sets the time and date

This watch receives GPS signals from GPS satellites to set the time and date based on the following information.

- Precise time and date based on the atomic clock
- Information about a time zone where you are  
(The current location is basically positioned by more than 4 GPS satellites, and which zone of the total of 40 time zones around the world you are in is identified.)

\* To receive information about a time zone where you are, it is necessary to adjust the time zone.

→ **How to adjust the time zone** P. 18

- \* Unlike navigation equipment, this GPS solar watch is not designed to constantly receive GPS signals from GPS satellites without any operation. This watch receives GPS signals from GPS satellites only in the time zone adjustment mode, automatic or manual time adjustment mode.

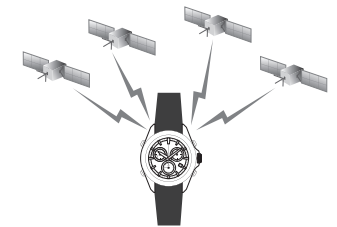

---

## Time zone

---

### □ Time zone

Based on Coordinated Universal Time (UTC), the standard time commonly used is adopted by countries and regions around the world. The standard time is determined by each country or region, and the region where the same standard time is adopted is referred to as the time zone, and presently, the time zone is divided into 40 zones as of January 2014.

### □ DST (Daylight Saving Time)

Depending on the area, DST (Daylight Saving Time) is individually set.

Daylight Saving Time means summer time, which is a system to lengthen daylight time by advancing 1 hour when daylight time is long in summer.

Daylight saving time has been adopted in about 80 countries, mainly in Europe and North America. The adoption and duration of daylight saving time vary depending on the country.

\* Daylight Saving Time is subject to change owing to circumstances of the country or region.

→ Set DST (Daylight Saving Time) [P. 19](#)

### □ Coordinated Universal Time (UTC)

UTC is the universal standard time coordinated through an international agreement. This is used as the official time for recording time around the world. The time obtained by adding a leap second to the "International Atomic Time (TAI)" determined based on the atomic clock around the world and coordinated in order to compensate for deviations from universal time (UT) which is astronomically determined is the UTC.

## The following functions are included

### When the region or time zone where the watch is used is changed

Adjust the time zone.

The watch displays the precise local time.

- Time zone adjustment P. 17
- Time Zone P. 6
- Time zone display and list of time zones around the world P. 12

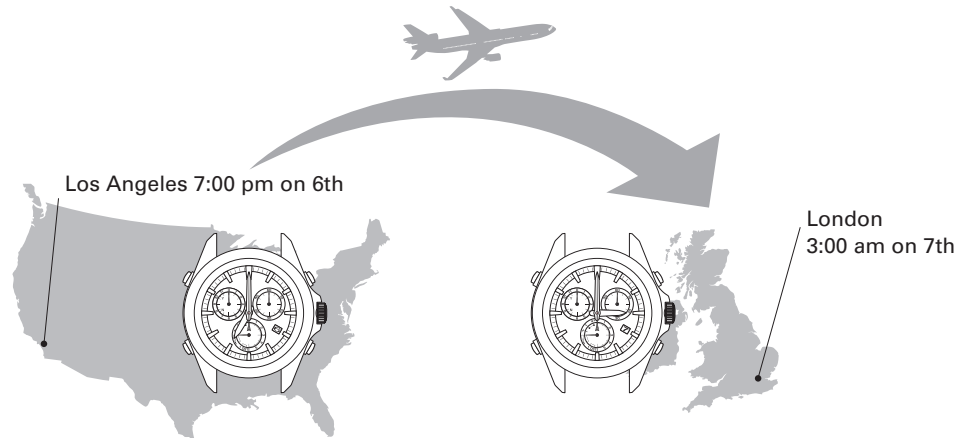

### To set only the time

The watch displays the precise time of the time zone that is set by operation of "manual time adjustment."

- How to manually adjust the time P. 24
- Check the time zone and DST (Daylight Saving Time) setting P. 20

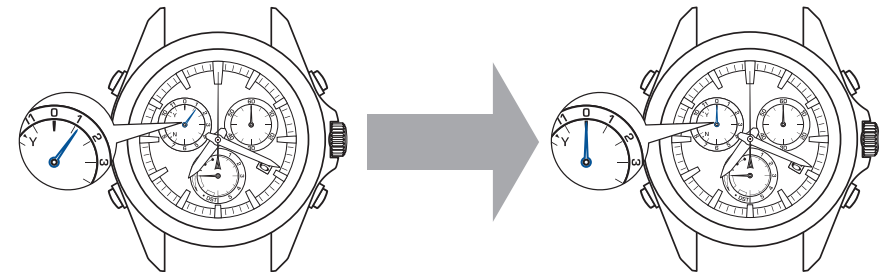

## How to check when the time zone information was configured for your watch

The case back shows the caliber-case number of your watch.

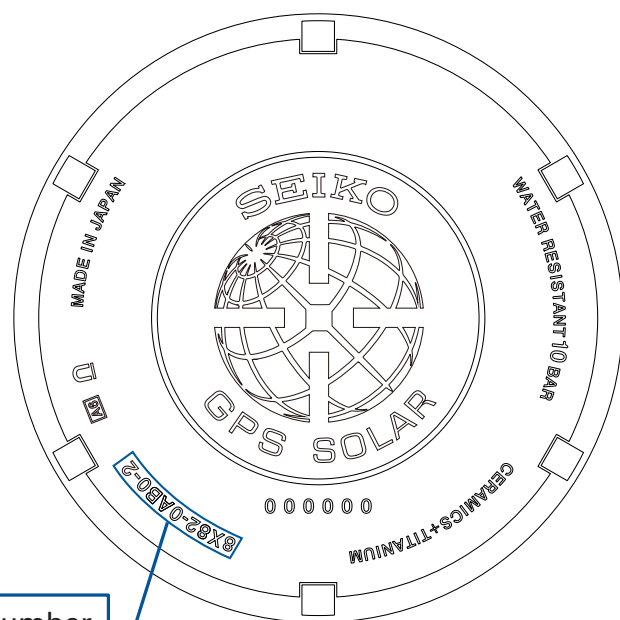

**Caliber-case number**  
The number to identify  
the watch type

By referring to caliber-case number shown on the case back, you will be able to determine when the time zone data was configured.

For more details, refer to the URL below.

<http://www.seikowatches.com/gpstimezonedatainfo/>

If the official time zone has changed in a region after the watch's time zone data was configured, the correct time will not be displayed even after receiving GPS signals. Please perform the following operations to display the correct time:

<To set the time of this watch in a region where the official time zone has changed>

1. Select the time zone appropriate for the current time in the target region by manual time zone setting.  
→ For details, please refer to "Handy Manual (caliber 8X82-mounted watch)."
2. Next, adjust the time by manual time adjustment.  
→ For details, please refer to "Handy Manual (caliber 8X82-mounted watch)."
3. When using the watch within the same time zone, the correct time will be displayed after automatic (GPS) or manual time adjustments.
4. When moving from a region where the official time zone has changed to a different time zone, then back to the region where the official time zone has changed, carry out the same operations from 1. - 3. as indicated above to display the correct time in the region where the official time zone has changed.

**CONTENTS**

<b>1. READ FIRST</b> .....	2	Check the leap second data reception was successful .....	29
<b>2. CONTENTS</b> .....	9	How to use the stopwatch .....	30
<b>3. BEFORE USE</b> .....	10	How to Use the Tachymeter .....	33
Names of the parts .....	10	<b>5. IN CASE OF AN UNUSUAL MOVEMENT OF THE SMALL</b>	
Indicator hand display and reception result display .....	11	<b>SECOND HAND</b> .....	34
Time zone display and list of time zones around the world .....	12	Small second hand movement and watch state (energy depletion	
Check the charging status .....	13	forewarning function) .....	34
About charging .....	14	<b>6. TO PRESERVE THE QUALITY OF YOUR WATCH</b> .....	36
<b>4. BASIC OPERATION (HOW TO SET THE TIME/HOW TO RECEIVE</b>		Daily care .....	36
<b>GPS SIGNALS, ETC.)</b> .....	15	Performance and caliber / case number .....	36
Basic operation flow .....	15	Water resistance .....	37
Place where GPS signals can be easily received/Place where GPS		Magnetic resistance (Magnetic influence) .....	38
signals cannot be received .....	16	Band .....	39
When the region or time zone where the watch is used is changed		How to use an adjustable three-fold clasp .....	40
(Time Zone Adjustment) .....	17	Lumibrite .....	41
Set DST (Daylight Saving Time) .....	19	Power Source .....	42
Check the time zone and DST (Daylight Saving Time) settings .....	20	After-sale service .....	43
When boarding (in-flight mode (✕)) .....	21	<b>7. TROUBLESHOOTING</b> .....	44
To set the watch to the local time of the destination in an airplane,		When the watch is unable to receive GPS signals .....	44
etc. (Manual time zone setting) .....	22	When the stopwatch hands, the time / date or indicator hand	
To set only the time (manual time adjustment) .....	23	position is misaligned .....	46
Automatic time adjustment .....	25	Cancel the light detection .....	51
GPS signal reception .....	26	Troubleshooting .....	52
Leap second (Automatic leap second reception function) .....	27	<b>8. FUNCTION LIST/SPECIFICATIONS</b> .....	58
Check that reception was successful (reception result display) .....	28		

### Names of the parts

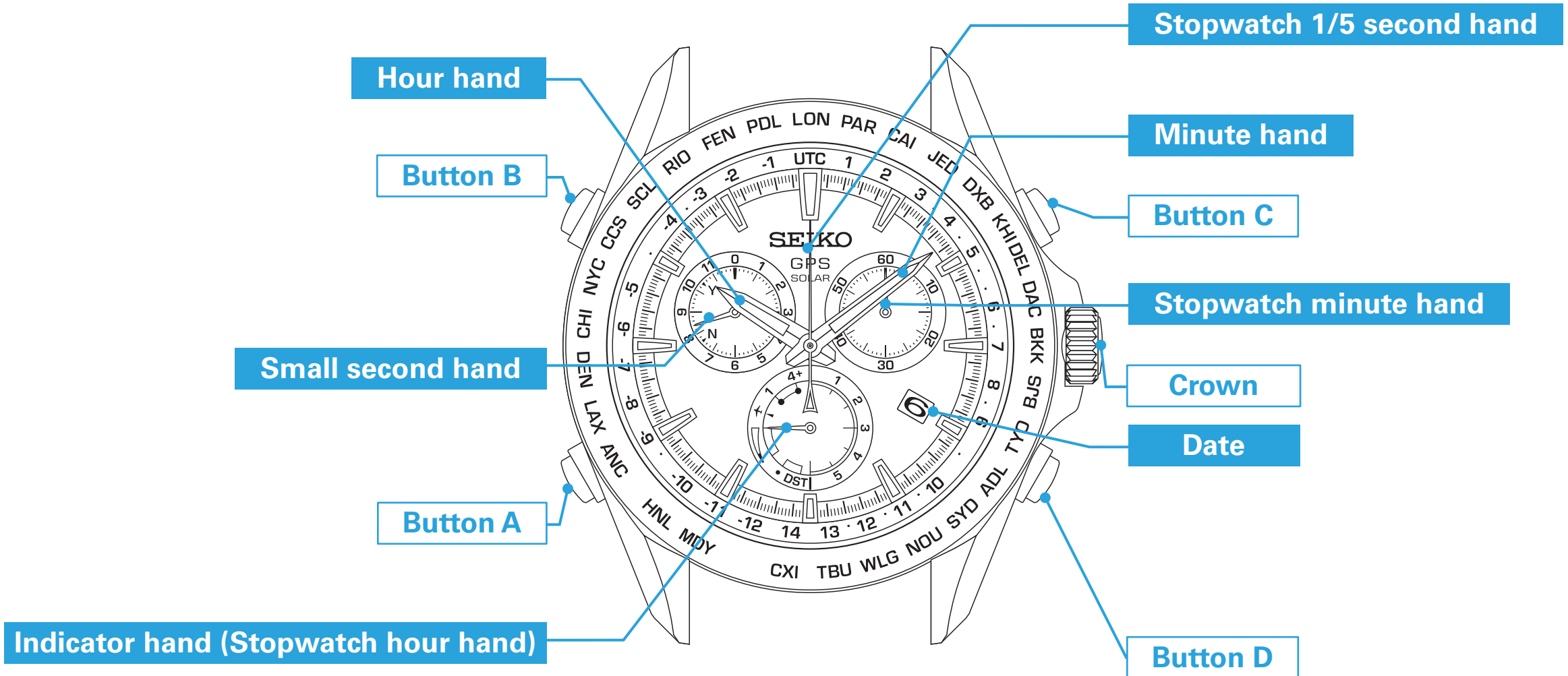

\* Display of city name may vary depending on the model.

Continued on the following page



## Indicator hand display and reception result display

### Display of receiving process

Receiving process	1 (time adjustment)	4+ (time zone adjustment)	Receiving leap second data
Display			

Check the reception result → P. 28  
 Manual time adjustment → P. 23  
 Time zone adjustment → P. 17

Automatic time adjustment → P. 25  
 Receive leap second data → P. 27

### Display of in-flight mode (✈)

Hand position	In-flight mode (✈) status
Display	

In-flight mode (✈) → P. 21

### Display of charging status

Hand position	full	middle	low
Display			

Check the charging status. → P. 13  
 How to charge the watch → P. 14

**Display of reception result**

Y ... Reception successful (52-second position)

N ... Reception failed (38-second position)

[Checking the reception result] → P. 28

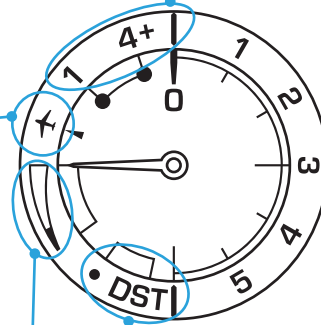

### Display of DST (Daylight Saving Time)

Hand position	· (OFF)	DST (ON)
Display		

Check DST (Daylight Saving Time) → P. 20  
 Set DST (Daylight Saving Time) → P. 19

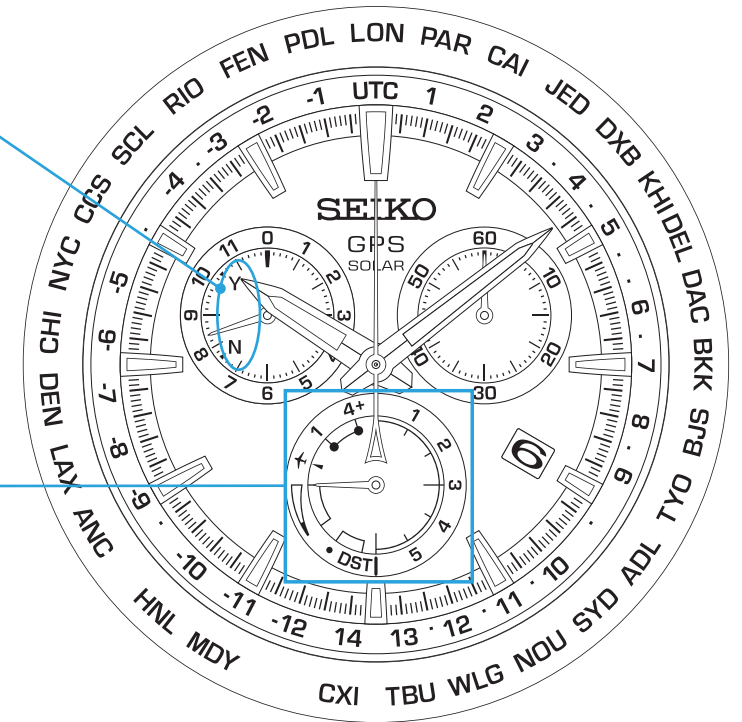

\*Position of each display may differ depending on the model (design).

Continued on the following page



## Time zone display and list of time zones around the world

The following list shows the relationship between displays of the bezel and dial ring and time difference from the UTC. Please refer to the second hand positions below to set the time zone or to check the time zone setting.

DST (Daylight Saving Time) is used in time zones with a ★ mark.  
 In the Lord Howe Island time zone in Australia with a ☆ mark, the time is advanced by 30 minutes while DST (Daylight Saving Time) is in effect.  
 This watch corresponds to DST in the Lord Howe Island time zone.

\* Each time zone is based on data as of January 2014.

**Display of time zone**  
 Representative city names...  
 29 cities among the total of 40 time zones around the world  
 Time difference...  
 +14 hours ~ -12 hours  
 [Check the time zone] → P. 20  
 [Time Zone Adjustment] → P. 17

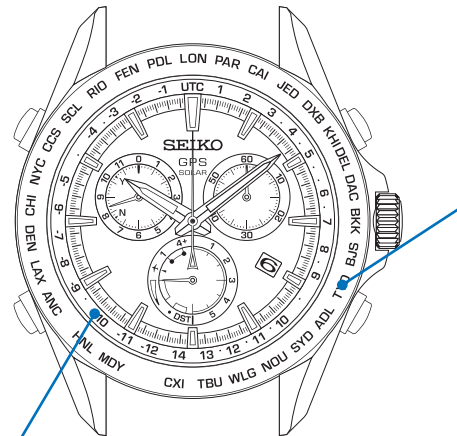

**Display of time difference**

City code	Display of time difference	City name	UTC ± hours
LON	UTC	★ London	0
PAR	1	★ Paris/★ Berlin	+1
CAI	2	★ Cairo	+2
JED	3	Jeddah	+3
—	•	★ Tehran	+3.5
DXB	4	Dubai	+4
—	•	Kabul	+4.5
KHI	5	Karachi	+5
DEL	•	Delhi	+5.5
—	•	Kathmandu	+5.75
DAC	6	Dhaka	+6
—	•	Yangon	+6.5
BKK	7	Bangkok	+7

City code	Display of time difference	City name	UTC ± hours
BJS	8	Beijing	+8
—	•	Eucla	+8.75
TYO	9	Tokyo	+9
ADL	•	★ Adelaide	+9.5
SYD	10	★ Sydney	+10
—	•	☆ Lord Howe Island	+10.5
NOU	11	Nouméa	+11
—	•	Norfolk Island	+11.5
WLG	12	★ Wellington	+12
—	•	Chatham Islands	+12.75
TBU	13	Nuku'alofa	+13
CXI	14	Kiritimati	+14
—	-12	Baker Island	-12
MDY	-11	Midway islands	-11

City code	Display of time difference	City name	UTC ± hours
HNL	-10	Honolulu	-10
—	•	Marquesas Islands	-9.5
ANC	-9	★ Anchorage	-9
LAX	-8	★ Los Angeles	-8
DEN	-7	★ Denver	-7
CHI	-6	★ Chicago	-6
NYC	-5	★ New York	-5
CCS	•	Caracas	-4.5
SCL	-4	★ Santiago	-4
—	•	★ St. John's	-3.5
RIO	-3	★ Rio de Janeiro	-3
FEN	-2	Fernando de Noronha	-2
PDL	-1	★ Azores	-1

\* The displays of city code and the time difference from UTC are Subject to change depending on model.  
 \* “.” between figures of the display of time difference shows that there is a time zone in that place.

## Check the charging status



The indicator hand position shows whether this watch is able or unable to receive GPS signals. In addition, for the low charging state, the movement of the second hand shows the energy depletion state in further detail.

\* GPS signal reception requires a lot of energy. Keep in mind to regularly charge the watch by expose to light. → **About charging** P. 14

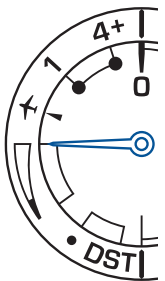
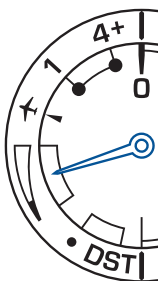
Reception is allowed

Indicator display	Charging status	Solution
	full	Reception is allowed. → <b>Proceed to P. 15</b>
	middle	Reception is allowed, but keep in mind to charge the watch. <b>About charging</b> → P. 15

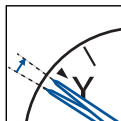
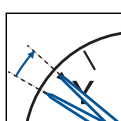
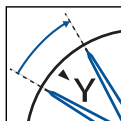
Reception is not allowed

Indicator display	Movement of second hand	Charging status	Solution
	1-second interval movement 	low	The watch is unable to receive GPS signals, but has energy to operate. <b>About charging</b> → P. 14
	2-second interval movement 		The watch is unable to receive GPS signals, and does not have energy to operate. (The energy depletion forewarning function is activated. → P. 34)
	5-second interval movement 		
	—	The charging status is not displayed for the in-flight mode (✕).	Reset the in-flight mode (✕) as long as possible. → <b>Reset the in-flight mode (✕) P. 21</b> When the indicator hand points to "E," charge the watch following the above.

## About charging

### How to charge the watch

Expose the dial to light to charge the watch.

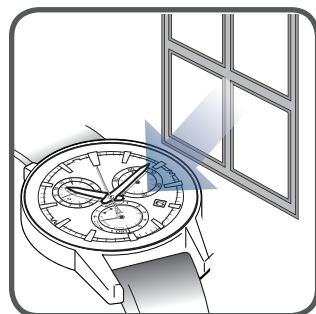

To ensure optimal performance of the watch, make sure that the watch is kept sufficiently charged at all times.

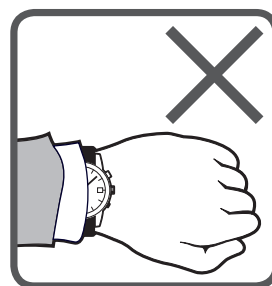

Under the following situations, the energy of the watch is likely to be depleted, resulting in stoppage of the watch.

- The watch is concealed under a sleeve.
- The watch is used or stored under conditions where it cannot be exposed to light for a long time.

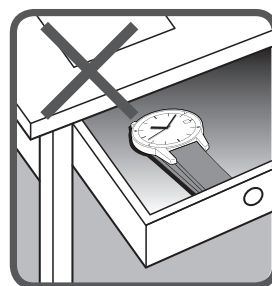

- \* When charging the watch, make sure that the watch is not heated to a high temperature. (The operational temperature range is between -10 °C and +60 °C (14 °F and 140 °F).)
- \* When first using the watch or starting to use the watch after it has stopped because of the energy depletion, sufficiently charge the watch referring to the table on the page at the right.

### Standard Charging Time

GPS signal reception consumes a lot of energy. It is necessary to charge the watch by exposing it to light so that the indicator hand points to the “middle” or “full” position. (If the charging status is displayed as “low,” the reception will not start even with manual GPS signal reception.)

→ Check the charging status. [P.13](#)

Illumination lx (LUX)	Light source	Condition (Example)	From the state where the watch is stopped (not charged)		In the state where the hand moves (the watch is charged)
			To fully charged	To one-second interval movement is secured	
700	Fluorescent light	General offices	—	—	3.5 hours
3,000	Fluorescent light	30W 20cm	420 hours	12 hours	1 hours
10,000	Fluorescent light Sunlight	Cloudy day 30W 5 cm	115 hours	4 hours	15 minutes
100,000	Sunlight	Sunny day (Under the direct sunlight on a summer day)	50 hours	1.5 hours	10 minutes

The figures of “Time required for charging the watch to start moving at one-second intervals” are estimations of time required to charge the stopped watch by exposing it to light until it moves at steady one-second intervals. Even if the watch is partially charged for a shorter period, the watch will resume one-second- interval movement. However, it may shortly return to two-second-interval movement. Use the charging time in this column as a rough guide for sufficient charging time.

- \* The required charging time slightly varies depending on the design and the dial color of the watch.

## Basic operation flow

### 1. Check the place where GPS signals can be easily received

→ Place where GPS signals can be easily received/Place where GPS signals cannot be received [P. 16](#)

Place where GPS signals can be easily received

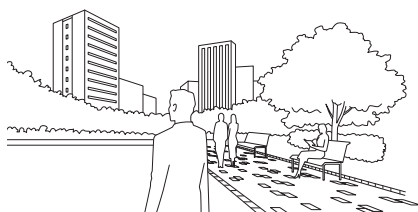

Outdoors under an open sky with good visibility

- When the region or time zone where the watch is used is changed
- To set only the time

Place where GPS signals cannot be received

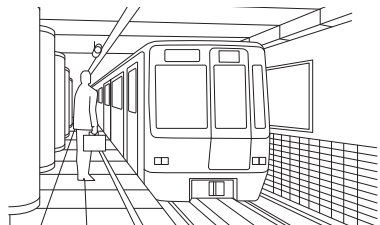

Example: Within a subway station

### 2. Set the time zone and set the time and date

< Setting by GPS signal reception >

- Receive GPS signals, set the time zone and set the time and date
- Set DST (Daylight Saving Time) as necessary

→ [How to adjust the time zone P. 18](#)

→ [Set DST \(Daylight Saving Time\) P. 19](#)

Set only the time

→ [How to manually adjust the time P. 24](#)

< Manual setting >

→ [Check the time zone and DST \(Daylight Saving Time\) setting P. 20](#)

Time zone setting is not correct

→ [How to manually set the time zone P. 22](#)

Time zone setting is correct

→ [How to manually set the time P. 45](#)

## Place where GPS signals can be easily received/Place where GPS signals cannot be received

There are places where GPS signals can be easily received and places where GPS signals cannot be received.

### ○ Easy to receive

- Outdoors under an open sky with good visibility

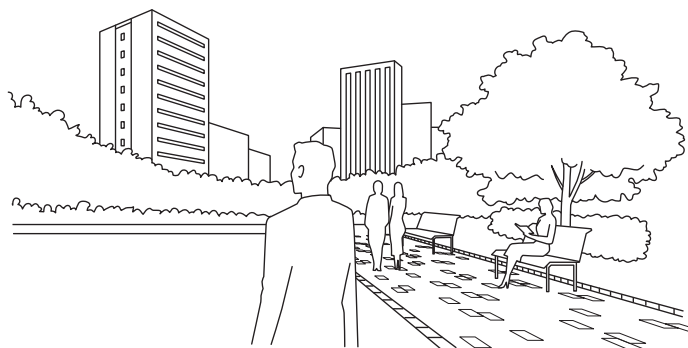

### △ Difficult to receive

- The smaller the sky, the more difficult it is to receive GPS signals. In addition, it will also be difficult to receive GPS signals, if there is something that obstructs the GPS signals during reception (in particular, during time zone adjustment).

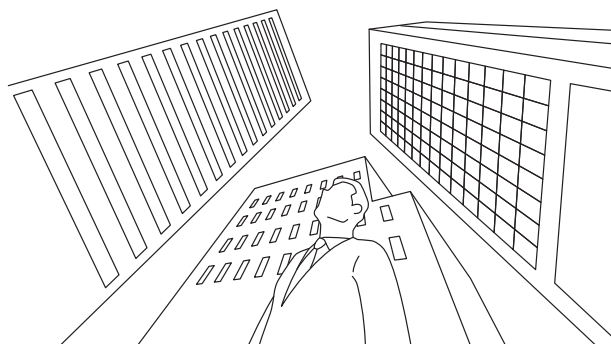

- Examples:
- Between tall buildings
  - Near wooded area
  - Station/Airport
  - Indoors with windows
  - \*GPS signals cannot be received depending on window glass type. Refer to the "X Cannot receive."

### ✕ Cannot receive

- The sky cannot be seen or only part of the sky can be seen.
- There is something hindering the reception.

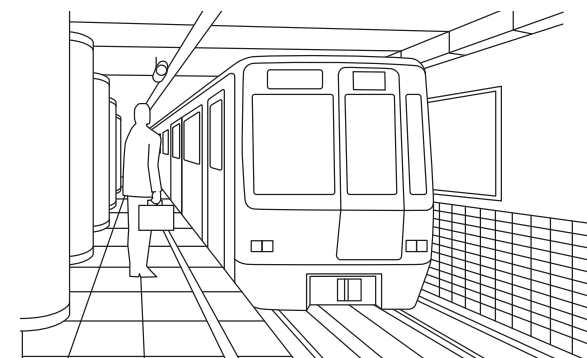

- Examples:
- Indoors without windows
  - Underground
  - During passage of a tunnel
  - Through special glass with thermal emission shield effect, etc.
  - Close to equipment generating noise or performing wireless communications

## When the region or time zone where the watch is used is changed (Time Zone Adjustment)

### Time zone adjustment



The time zone where you are is localized to adjust the watch to the precise current time by just one button operation\* anywhere in the world.

\* DST (Daylight Saving Time) can be set manually.

→ How to adjust the time zone [P. 18](#)

- \* Failure or success of reception depends on the reception environment.  
→ Place where GPS signals can be easily received/Place where GPS signals cannot be received [P. 16](#)
- \* Even when the reception is successful, DST (Daylight Saving Time) cannot be automatically set. Set DST manually.  
→ Set DST (Daylight Saving Time) [P. 19](#)
- \* GPS signal reception consumes a lot of energy.  
Keep in mind to regularly charge the watch by expose to light so that the indicator hand points to the "level position (middle)" or "F (full)."  
→ How to charge the watch [P. 14](#)  
If the charging status is displayed as "E (low)," the reception will not start even with operation of GPS signal reception.  
→ Check the charging status. [P. 13](#)
- \* When the stopwatch is moving, the reception function will not be activated.

### Precautions on time zone adjustment

If the time zone is adjusted near a time zone boundary, the time of the adjacent time zone may be displayed.

In some areas the boundaries observed by the watch may not exactly correlate to the actual time zone markers on the land. This does not indicate a malfunction.

In this case, set the time zone in the manual time zone setting mode.

→ How to manually set the time zone [P. 22](#)

When the time zone is adjusted while traveling on land, avoid time zone boundaries to carry out time zone adjustment in the representative cities in the time zone whenever possible. In addition, when the watch is used near time zone boundaries, make sure to check the time zone setting, and manually set the time zone as necessary.

Continued on the following page



## How to adjust the time zone

### 1 Go to a place where GPS signals can be easily received

Move to the outdoors under an open sky with good visibility.

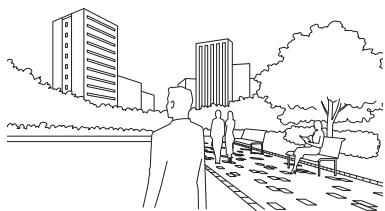

→ Place where GPS signals can be easily received/Place where GPS signals cannot be received [P. 16](#)

### 2 Continue to press Button B (6 seconds), and then release it when the second hand moves to the 30-second position.

\* Although the second hand moves to the 0-second position 3 seconds after pressing Button B, continue to press it.

When the second hand has reached the 30-second position, reception is started. The indicator hand points to "4+."

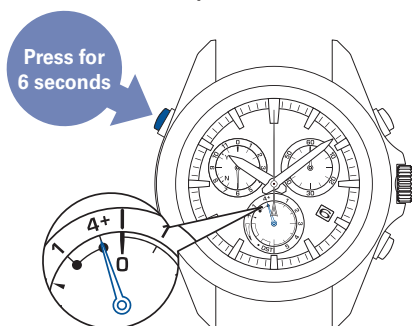

\* While the indicator hand points to "E" or ✈, reception is not started even with operation for reception.

When the hand points to "E," charge the watch by expose to light.

→ [How to charge the watch P. 14](#)

Check whether the watch is able/unable to receive GPS signals

→ [Check the charging status P. 13](#)

When the hand points to ✈, reset the in-flight mode (✈).

→ [How to reset in-flight mode \(✈\) P. 21](#)

\* When the stopwatch is operating, the reception function will not be activated.

### 3 Direct the watch face upward and wait

\* Please note that it may be difficult to receive GPS signals while you are in motion.



**It takes a maximum of 2 minutes to complete reception.**

\* It depends on the receiving conditions.

< Display during reception (= satellites acquisition status) >

The second hand indicates ease of receiving (= number of GPS satellites from which GPS signals are received).

\* The larger the number of acquired satellites there are, the easier it is to receive GPS signals.

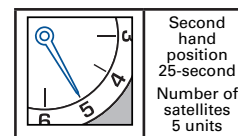

Second hand position 25-second  
Number of satellites 5 units

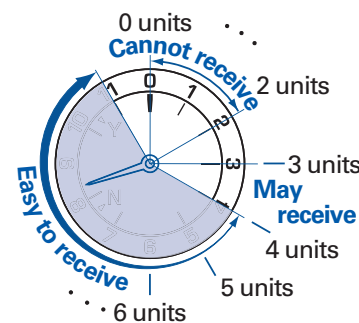

\* Even when the hand points to 4 units or more, reception may not be allowed.

\* To cancel the reception, press Button A.

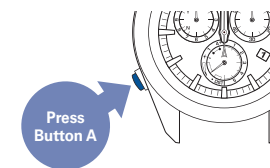

### 4 When the second hand points to "Y" or "N," reception is completed.

The reception result is displayed for 5 seconds.

Then, the hour and minute hands move, and the time and date are adjusted. (The time zone is also adjusted to the local time zone.)

Reception result display	Y: Successful (52-second position)	N: Failed (38-second position)
Display		
State	Use the watch as it is.	→ When the reception result is displayed as "N" <a href="#">P. 16</a>

Check that the reception is successful after the watch returns to the time display mode.

→ [Check that the reception was successful P. 28](#)

→ [Check the time zone setting P. 17](#)

\* During movement of the date, the buttons and crown cannot be operated.

\* Manually set DST (Daylight Saving Time).  
→ [Set DST \(Daylight Saving Time\) P. 19](#)

## Set DST (Daylight Saving Time)

### Turn ON DST (Daylight Saving Time)

DST (Daylight Saving Time) can be manually set.

- \* DST (Daylight Saving Time) is not automatically changed.
  - \* ON/OFF of the DST (Daylight Saving Time) is not automatically changed over even with operation of time zone adjustment/manual time zone setting.
- When traveling to a region where DST (Daylight Saving Time) is not adopted from a region where it is adopted, turn off the DST (Daylight Saving Time) setting.

#### 1 Pull out the crown to the first click

The indicator hand moves to indicate the current DST (Daylight Saving Time) setting.

The stopwatch 1/5 second hand moves to indicate the current time zone.

< When DST (Daylight Saving Time) setting is OFF >

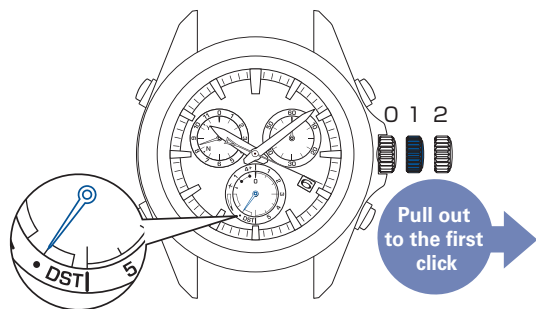

\* If the stopwatch is being used, it will be reset.

#### 2 Continue to press Button B (3 seconds)

The indicator hand moves to point to "DST (ON)," and the hour and minute hands advance by one hour.

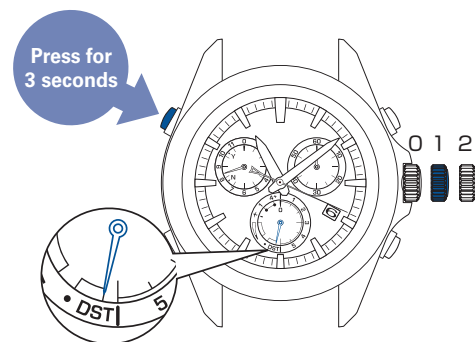

\* In the Lord Howe Island time zone in Australia, the time is advanced by 30 minutes while DST (Daylight Saving Time) is in effect. This watch corresponds to DST (Daylight Saving Time) in Lord Howe Island time zone.

#### 3 Push the crown back in

The indicator hand returns to display the charging status.

The stopwatch 1/5 second hand returns to the 12 o'clock position.

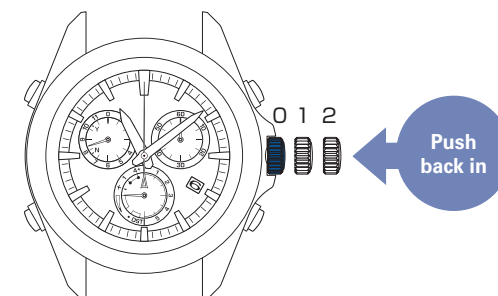

### Turn OFF DST (Daylight Saving Time)

Carry out operation of ① to ③ in the state where DST (Daylight Saving Time) setting is ON.

In operation of ②, adjust the indicator hand to the "OFF" position as shown in the figure at the right.

The hour and minute hands return by one hour.

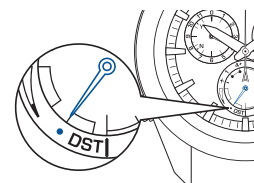



## Check the time zone and DST (Daylight Saving Time) settings

### 1 Pull out the crown to the first click

The Stopwatch 1/5-second hand moves to display the currently set time zone.  
The indicator hand indicates DST (Daylight Saving Time) setting.

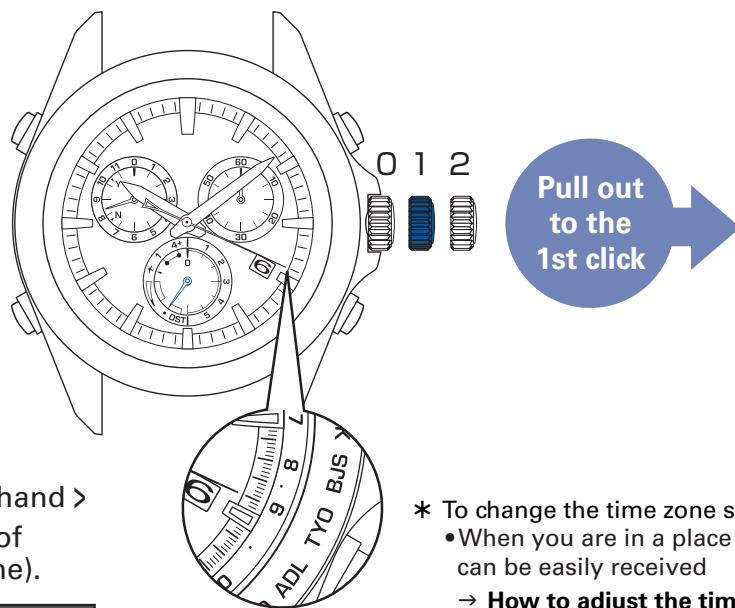

< Display of the indicator hand >  
Displays ON/OFF setting of  
DST (Daylight Saving Time).

DST	(OFF)	DST (ON)
Display		

- \* To change the time zone setting
  - When you are in a place where GPS signals can be easily received  
→ **How to adjust the time zone P.18**
  - When you are in a place where GPS signals cannot be received  
→ **How to manually set the time zone P.22**
- \* For the relationship between the stop watch 1/5-second hand position and time zone, refer to the "Time zone display and list of time zones around the world P.12".

### 2 Push the crown back in

The stopwatch 1/5-second hand returns to the 0-second position. The indicator hand returns to the display of charging status.

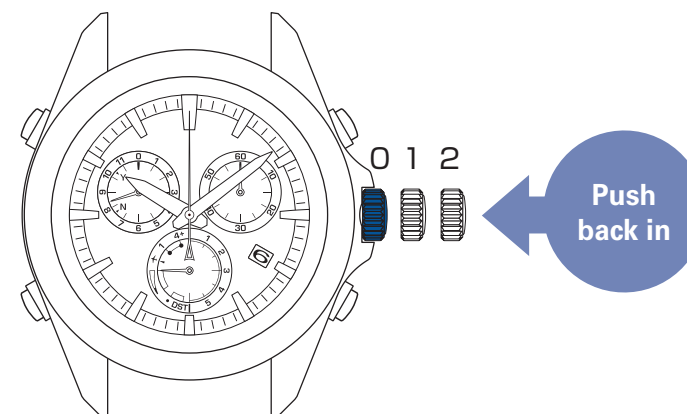

## When boarding (in-flight mode (✈))

### □ In-flight mode (✈)

Set to the in-flight mode (✈) where the reception may influence operation of other electronics devices in an airplane, etc.

In the in-flight mode (✈), the GPS signal reception (time zone adjustment, manual time adjustment, and automatic time adjustment) does not work.

< In-flight mode (✈) >

The indicator hand points to ✈.



\* When the in-flight mode (✈) is reset, the indicator hand indicates the charging status.

### □ Set to the in-flight mode (✈).

#### 1 Continue to press Button A (3 seconds)

The indicator hand indicates the charging status.

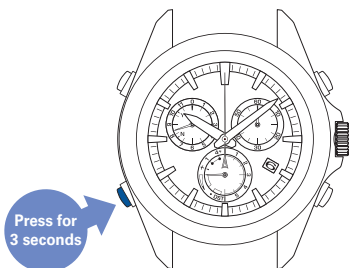

The indicator hand points to ✈.

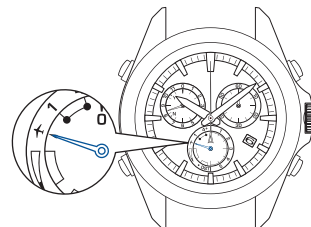

When the in-flight mode (✈) is set, the indicator hand does not indicate the charging status.

→ To set the watch to the local time of the destination in an airplane, etc. (Manual time zone setting) [P. 22](#)

### □ Reset the in-flight mode (✈).

Carry out operation ①.

When the indicator hand points to "the charging status" in the figure at the right, the in-flight mode (✈) is reset.

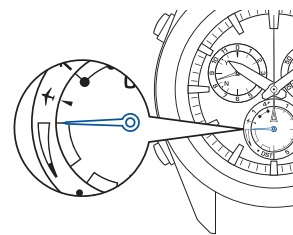

\* The display when the charging status is "full"

## To set the watch to the local time of the destination in an airplane, etc. (Manual time zone setting)

### Manual time zone setting

In places where the time zone cannot be adjusted, the time zone can be set manually.

→ Place where GPS signals can be easily received/Place where GPS signals cannot be received P. 16

Set the time zone with reference to the "Time zone display and list of time zones around the world P. 12," to set the watch to the local time and date.

\* Refer to "Set DST (Daylight Saving Time) P. 19;" to set DST (Daylight Saving Time).

### How to manually set the time zone

#### 1 Pull out the crown to the first click

The Stopwatch 1/5-second hand moves to display the currently set time zone.

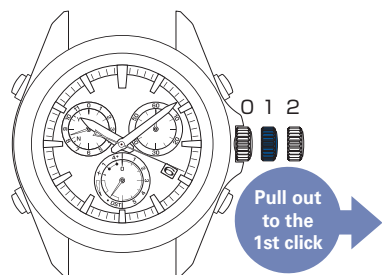

#### 2 Turn the crown and set the stopwatch 1/5-second hand to the time zone of the destination

When the crown is turned, the stopwatch 1/5-second hand moves to the next zone.

\* For the relationship between the stop watch 1/5-second hand position and time zone, refer to the "Time zone display and list of time zones around the world P.12".

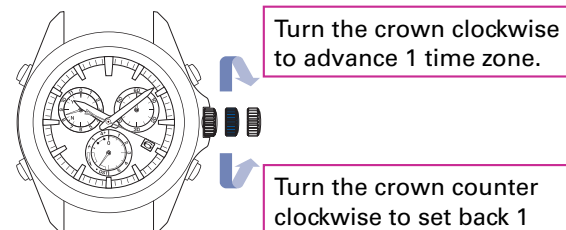

< Display of the indicator hand >  
Displays ON/OFF setting of DST (Daylight Saving Time).

DST	OFF	ON
Display		
hand position	•	DST

\* If DST (Daylight Saving Time) is not correct, change over ON/OFF with reference to "Set DST (Daylight Saving Time) P.19" after operation of ②.

#### 3 Push the crown back in

The stopwatch 1/5-second hand returns to the 0-second position. The indicator hand returns to the display of charging status.

\* During movement of the date, the buttons and crown cannot be operated.

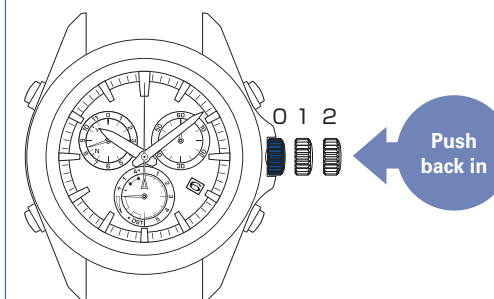

## To set only the time (manual time adjustment)

### Manual time adjustment



The watch can be set to the precise current time of the currently set time zone.  
(The time zone is not changed.)

→ How to manually adjust the time [P. 24](#)

→ Check the time zone setting [P. 20](#)

- \* In the manual time adjustment, the precise time of the currently set time zone is displayed.  
When the region or time zone where the watch is used is changed, adjust the time zone. → **How to adjust the time zone** [P. 18](#)  
(If the time zone is adjusted, the time zone setting, time and date will be adjusted, so it is not necessary to manually adjust the time immediately thereafter.)
- \* DST (Daylight Saving Time) is not automatically set. Carry out the setting manually. → **Set DST (Daylight Saving Time)** [P. 19](#)
- \* Failure or success of reception depends on the reception environment. → **Place where GPS signals can be easily received/Place where GPS signals cannot be received** [P. 16](#)
- \* At the time when the reception was successful by manually adjusting the time, automatic time adjustment may be performed. For details, refer to "Automatic time adjustment [P. 25](#)."
- \* GPS signal reception consumes a lot of energy.  
Keep in mind to charge the watch regularly by expose to light so that the indicator hand points to the "level position (middle)" or "F (full)." → **How to charge the watch** [P. 14](#)  
(When the charging status becomes "E (low)," the reception will not start even with operation of GPS signal reception.)  
→ **Check the charging status.** [P. 13](#)
- \* When the stopwatch is moving, the reception function will not be activated.

Continued on the  
following page

## How to manually adjust the time

### 1 Go to a place where GPS signals can be easily received

Move to the outdoors under an open sky with good visibility.

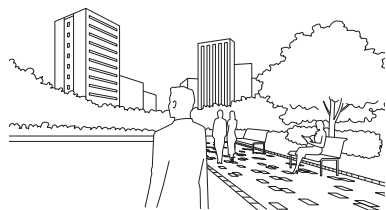

→ Place where GPS signals can be easily received/  
Place where GPS signals cannot be received [P. 16](#)

### 2 Continue to press Button B (3 seconds), and then release it when the second hand moves to the 0-second position.

When the second hand has reached the 0-second position, reception is started. The indicator hand points to "1"

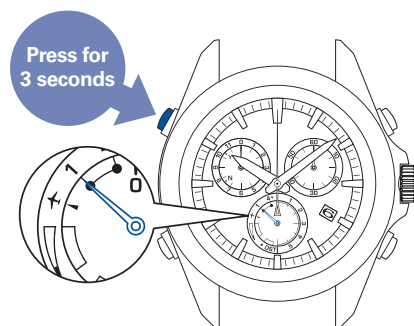

- \* While the indicator hand points to "E" or ✈, reception is not started even with operation for reception. When the hand points to "E," charge the watch by exposing it to light.  
→ [How to charge the watch P. 14](#)  
→ [Check the charging status. P. 13](#)
- When the hand points to ✈, reset the in-flight mode (✈).  
→ [How to reset in-flight mode \(✈\) P. 21](#)

\* If the stopwatch is moving, the reception will not start even with operation of GPS signal reception.

### 3 Direct the watch face upward and wait

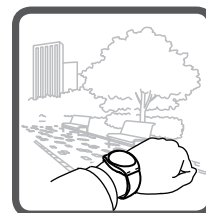

**It takes up to one minute to complete reception.**

\* The reception time depends on the reception conditions.

< Display during reception (= satellites acquisition status) >

The second hand indicates ease of receiving (= number of GPS satellites from which GPS signals are received).

\* To acquire only time information, the number of satellites necessary for reception is one.

Number of acquired satellites	1	0
Display		
State	Easy to receive	Cannot receive

\* To cancel the reception, press Button A.

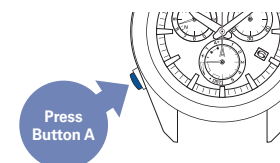

### 4 When the second hand points to "Y" or "N," reception is completed.

The reception result is displayed for 5 seconds.

Then, the hour and minute hands move, and the time and date are adjusted.

Reception result display	Y: Successful (52-second position)	N: Failed (38-second position)
Display		
State	Use the watch as it is.	→ When the reception result is displayed as "N" <a href="#">P. 16</a>

Check that the reception is successful after the watch returns to the time display mode.

→ [Check that the reception was successful P. 28](#)

When the time is not correct even if "Y" is displayed, the time zone may not correspond to the region where you are. Check the time zone setting.

→ [Check the time zone and DST \(Daylight Saving Time\) settings P. 20](#)

\* During movement of the date, the buttons and crown cannot be operated.

\* Manually set DST (Daylight Saving Time).

→ [Set DST \(Daylight Saving Time\) P. 19](#)

## Automatic time adjustment

This watch can be set to the precise current time by automatically receiving GPS signals by exposure to bright light outdoors under an open sky to adjust the time.

In addition, when the watch is concealed under a sleeve and the dial is not exposed to sufficient light even if outdoors under an open sky, the watch stores the time of the previous successful manual time adjustment (or time zone adjustment), and automatically starts time adjustment at the same time.

- \* In a place without good visibility, GPS signals cannot be received. → **Place where GPS signals can be easily received/Place where GPS signals cannot be received** P. 16
- \* If the energy is sufficiently charged, automatic reception will be performed every day.
- \* The automatic time adjustment is performed at most once per day. Therefore, even if automatic time adjustment has failed, the next automatic time adjustment will be performed the next day or thereafter.
- \* The time zone is not adjusted in the automatic time adjustment.  
When the region where the watch is used is changed, please carry out time zone adjustment. How to adjust the time zone P. 18

### ◁ When it is difficult to expose to light sufficiently ▷

Even if outdoors under an open sky, when the watch is concealed under a sleeve in winter time, etc., in an area where the daylight hours are short, or when the watch is not likely to be exposed to sufficient light for a long time due to bad weather, the watch is designed to allow for automatic time reception at the time when the manual time adjustment was successful the last time.

When the watch is exposed to the operating environment above, automatic time adjustment is likely to be successful by making manual time adjustment successful in time periods where the watch is frequently used in a place where GPS signals can be easily received under an open sky.

→ **How to manually adjust the time** P. 24

However, as the watch judges to start automatic time adjustment taking into consideration the following conditions, the watch does not necessarily start automatic time adjustment by exposure to bright light.

- Charging status
- Past reception status

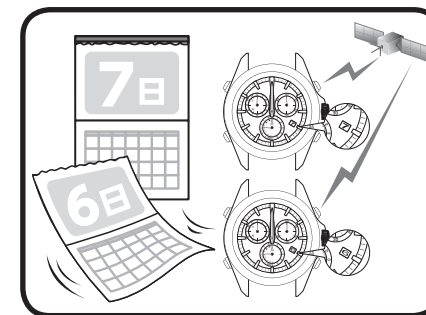

- \* When the indicator hand points to "E (low)," or in the in-flight mode (✈), automatic time adjustment does not work.  
When the indicator hand points to "E," charge the watch by expose to light. → **How to charge the watch** P. 14  
→ **Check the charging status** P. 13
- \* When the energy is reduced, the period for which automatic time adjustment is not performed becomes longer. Keep in mind to charge the watch regularly.
- \* If the time zone adjustment or manual time adjustment is performed before the automatic time adjustment is started, the automatic time adjustment is not performed on that day.
- \* When the stopwatch is moving, the automatic time adjustment is not performed.



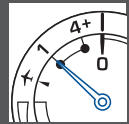

## GPS signal reception

GPS signal reception includes three types. Features for each type are as follows.

Reception method	Time adjustment	Time zone adjustment	Leap second data reception
Display	 How to manually adjust the time → P. 23 Automatic time adjustment → P. 25	 How to adjust the time zone → P. 17	
Features	<b>Time adjustment</b> Precise current time of the set time zone is displayed	<b>Time zone identification and time adjustment</b> Time zone where you are is identified, and the precise current time is displayed	<b>Leap second reception</b> Ready for leap second data reception and receiving leap second data → P. 27
Number of acquired satellites necessary for reception	One unit (to obtain only time information)	Basically more than 4 units (to obtain time information and time zone information)	—————
Time taken for reception	6 seconds to 1 minute	30 seconds to 2 minutes	30 seconds to 18 minutes
What kind of situation	To set the watch to the precise time while it is used in the same time zone	When the watch is used in a different time zone	This is automatically displayed after automatic time adjustment or manual time adjustment is performed on or after June 1st and December 1st.

### GPS signal reception Q & A

Q: When the watch is moved to a different time zone, does the watch automatically display the local time?

A: The watch does not automatically display the local time just by being moved. If you are in a place where GPS signals can be easily received, adjust the time zone. The watch automatically displays the local time.

When you are in a place where GPS signals cannot be received, manually set the time zone.

→ **Manual time zone setting** P. 22

The watch can be set to all time zones around the world.

Q: Is DST (Daylight Saving Time) automatically changed by receiving GPS signals?

A: Manually set DST (Daylight Saving Time).

→ **Set DST (Daylight Saving Time)** P. 19

(GPS signals from GPS satellites do not include information about DST (Daylight Saving Time).)

Even in the same time zone, some countries and regions do not adopt DST (Daylight Saving Time).

→ **DST (Daylight Saving Time)** P. 12

Q: Is it necessary to carry out special operation for years in which a leap second is added?

A: No special operation is necessary.

Since the watch receives leap second data at the same time of receiving GPS signals on or after June 1st and December 1st, a leap second is automatically added by periodically receiving GPS signals. For details, refer to "Leap second (automatic leap second reception function)" → P. 27."

## Leap second (Automatic leap second reception function)

### Leap second

The leap second is to compensate for deviations from the universal time (UT) which is astronomically determined and the "International Atomic Time (TAI).

"1 second" may be added (deleted) once a year or every few years.

### Automatic leap second reception function

A leap second is automatically added by receiving "leap second data" from GPS signals at the time of leap second addition (delete).

\* "Leap second data" includes information about future leap second addition and current leap second data.

### Receiving Leap Second Data

When the GPS signal reception is performed on or after December 1st and June 1st, the indicator hand displays as shown at the right.

When the leap second data reception is completed, the indicator hand returns to display the charging status. Use the watch as it is.

\* The leap second data reception is performed every half a year regardless of leap second addition.

**It takes up to 18 minutes to receive the leap second data.**

Receiving the leap second data

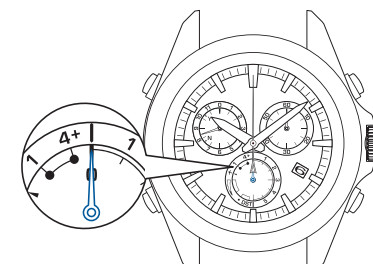

When GPS signals are received under the following conditions, the leap second data reception is also started.

- GPS signals are received after the system reset
- GPS signals have not been received for a long time
- Leap second data reception has failed

(Leap second data reception is performed again during the next GPS signal reception. It is repeated until the leap second data reception is successful.)



## Check that reception was successful (reception result display)

The type of reception and reception result (success or failure) of the last GPS signal reception is displayed for 5 seconds.

### 1 Press Button B once and then release it

The second hand and indicator hand display the reception result.

Press and then release



\* When Button B is kept pressed, the watch enters the Manual time adjustment operation.

### 2 Check that reception was successful (within 5 seconds)

The second hand displays the reception result (success/failure).

The indicator hand displays which of the last GPS signal reception was performed for time adjustment or time zone adjustment.

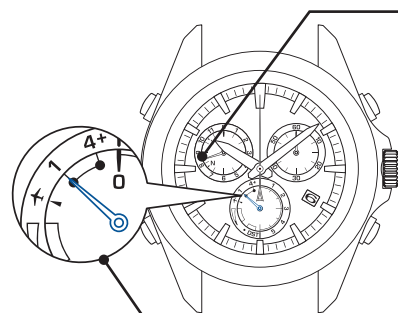

\* After 5 seconds have elapsed or when Button A is pressed, the watch returns to the time display mode.

Second hand: Reception result (success/failure)

Result	Successful	Failed
Display		
Position	<b>Y 52-second position</b>	<b>N 38-second position</b>

Indicator hand: Reception method (manual time adjustment or time zone adjustment)

Type	1 (Manual time adjustment)	4+ (Time zone adjustment)
Display		

### When the reception result is Y

• The reception was successful.  
Use the watch as it is.

### When the reception result is N

• Move to the outdoors where GPS signals can be easily received as necessary to receive GPS signals.

→ Place where GPS signals can be easily received/Place where GPS signals cannot be received [P. 16](#)

\* When approximately five days have elapsed after successful reception, the reception result display becomes "N."  
\* Even under a state where GPS signal cannot be received, the watch operates with quartz accuracy (at loss/gain  $\pm 15$  seconds per month).

When the reception has failed in any way, manually set the time and date.

→ How to manually set the time [P. 44](#)

## ■ Check the leap second data reception was successful

The reception result (success or failure) of the regular leap second data reception is displayed for 5 seconds.

### 1 Press Button B and then release it

The second hand and indicator hand display the reception result.

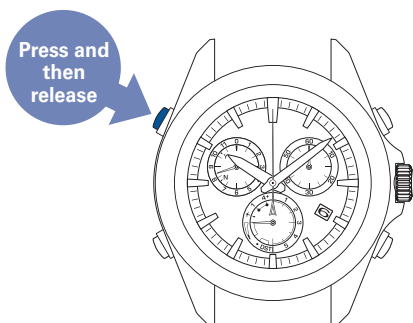

\* When Button B is kept pressed, the watch enters the Manual time adjustment operation.

### 2 The result of the reception is displayed

The second hand displays the result of the GPS signal reception (time adjustment or time zone adjustment).

The indicator hand points to "1" or "4+" which shows "time adjustment" or "time zone adjustment".

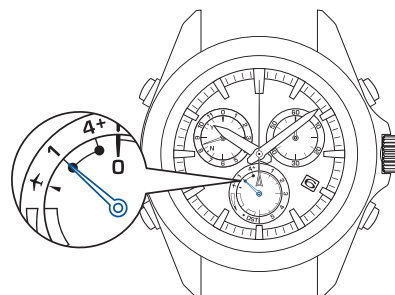

\* The indicator hand points to "4+" as a result of time zone adjustment.

Second hand: Reception result (successful / failed)

Result	Successful	Failed
Display		
Position	<b>Y 52-second position</b>	<b>N 38-second position</b>

\* After 5 seconds have elapsed or when Button A is pressed, the watch returns to the time display mode.

### 3 Press Button B and then release it while the result of the reception is displayed (for 5 seconds) in step 2

The second hand displays the result of the leap second data reception (successful / failed).

The indicator hand displays "0" of the leap second data reception.

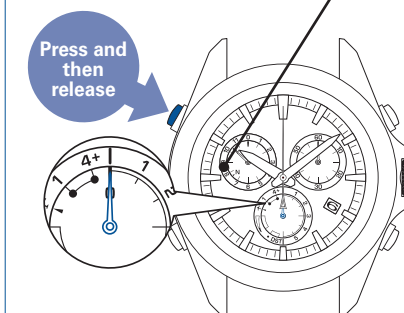

\* When Button B is kept pressed, the watch enters the Manual time adjustment operation.

\* After 5 seconds have elapsed, or when Button A is pressed, the watch returns to the time display mode.

Second hand: Reception result (successful / failed)

Result	Successful	Failed
Display		
Position	<b>Y 52-second position</b>	<b>N 38-second position</b>

When the leap second data reception result is Y (successful)

- The leap second data reception was successful. Use the watch as it is.

When the leap second data reception result is N (failed)

- The leap second data reception, periodically performed, has not been successful.

It will be performed automatically with the next GPS signal reception (automatic time adjustment/manual time adjustment). Use the watch as it is.

\* The leap second data is received on or after December 1<sup>st</sup> and June 1<sup>st</sup>.

\* Even when the leap second data reception has not been successful, the time is correct until the leap second data is added (deleted).

## How to use the stopwatch

### Stopwatch Basic Function

- The time can be measured and read for up to 5 hours 59 minutes 59 seconds, 8 in increments of 1/5 of a second.
- The time measured is indicated by the three stopwatch hands. After 6 hours, it will stop and reset.
- When the measurement reaches 10 minutes, the 1/5 second stopwatch hand stops at the 0-second position. When the buttons are operated to stop the stopwatch or to measure a split time, the 1/5 second stopwatch hand displays the measured second.

Stopwatch hour hand

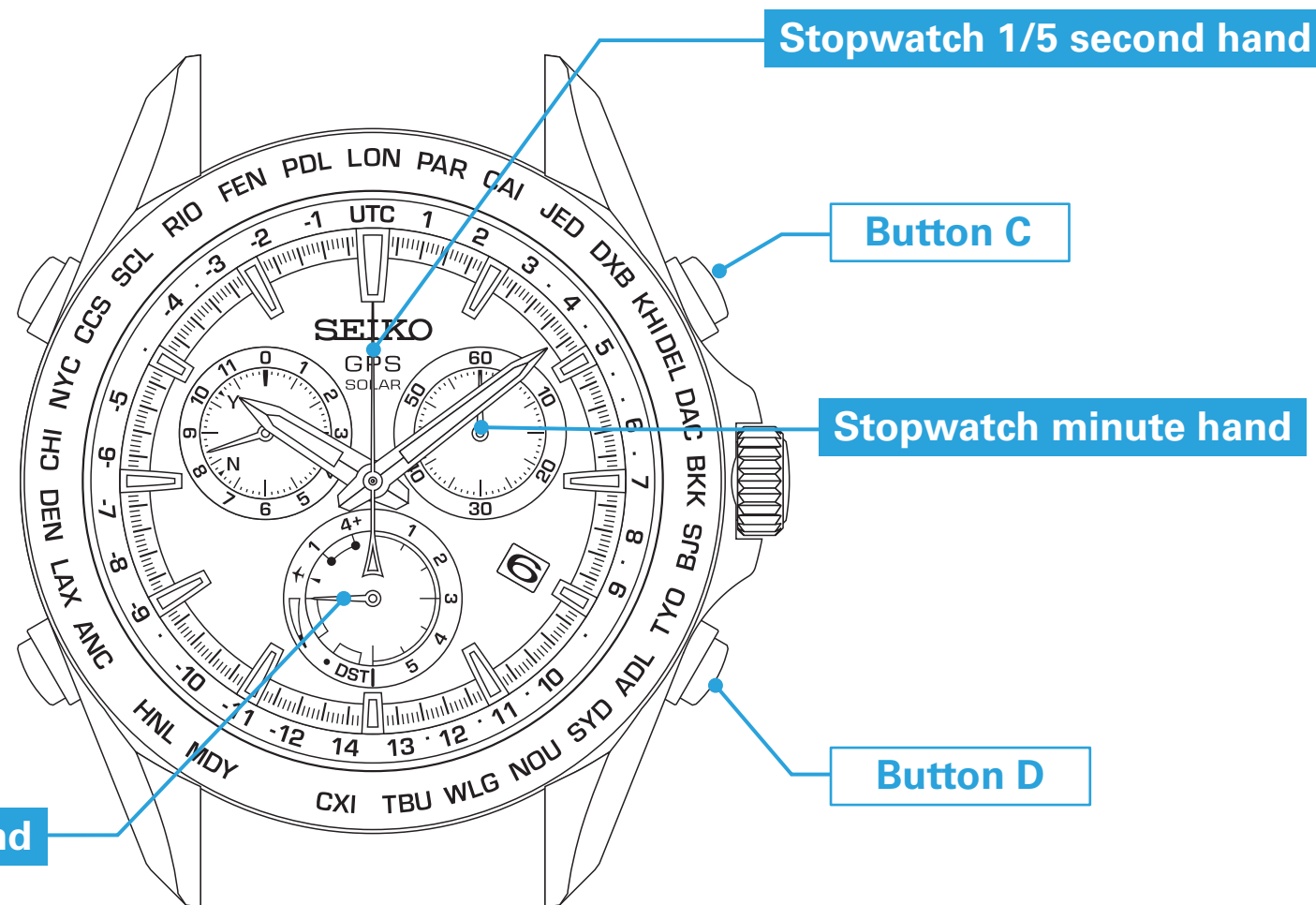

Stopwatch 1/5 second hand

Button C

Stopwatch minute hand

Button D

### Standard measurement



### Accumulated elapsed time measurement

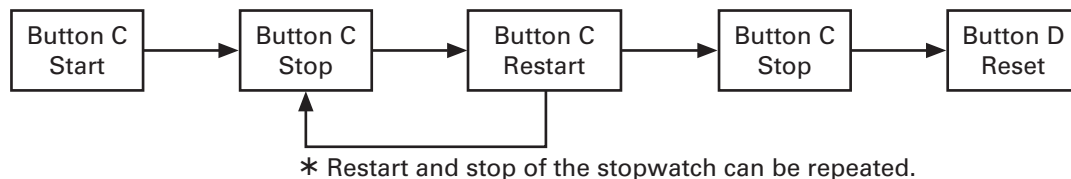

### Split time measurement

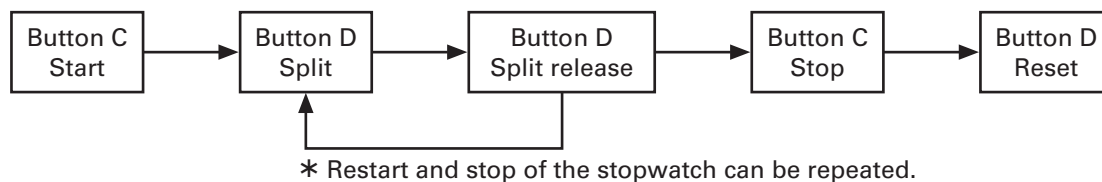

\* When the measurement reaches 6 hours in the split time measurement state, it stops automatically.  
The split time measurement will be reset and the hands will return to 0 o'clock 0 minute 0 second position. After that, the indicator hand will be switched to the charging status display.

### Measurement Of Two Competitors

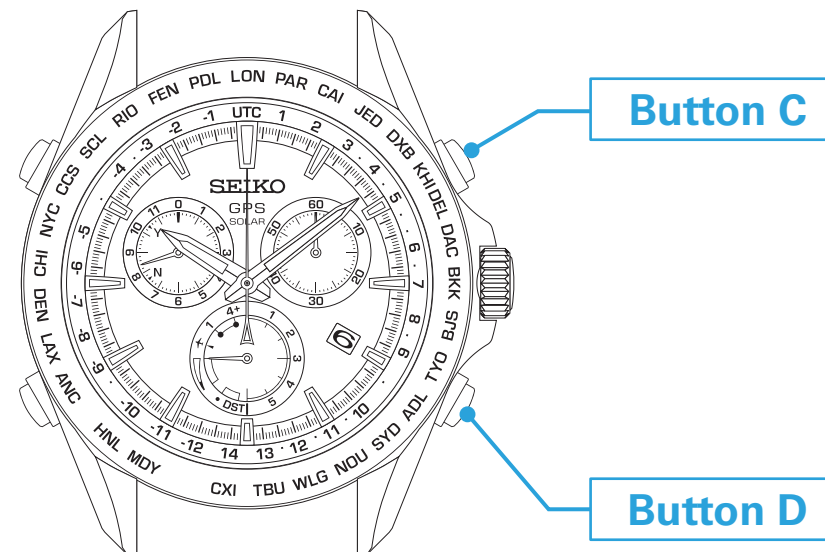
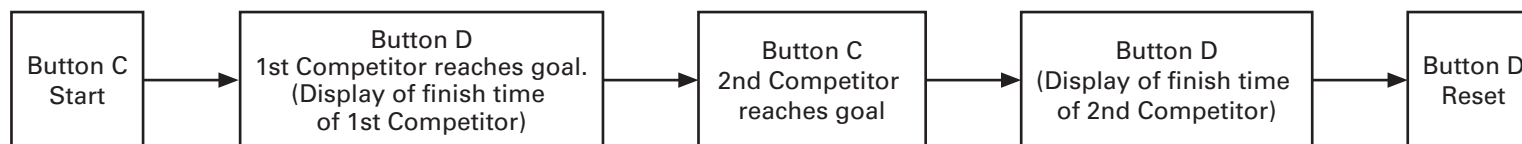

### ■ How to reset the stopwatch

•When the stopwatch hands are counting:

- ① Press button C to stop the stopwatch.
- ② Press button D to reset the stopwatch.

•When the stopwatch hands are stopped, one of the following three operations has occurred. Reset the stopwatch as follows:

[The stopwatch stopped in “Standard measurement” or “Accumulated elapsed time measurement.”]

- ① Press button D to reset the stopwatch.

[Split time was measured and remain displayed “Split time measurement”]

- ① Press button D. The split time is released and the stopwatch hands move quickly to indicate the measurement in progress.
- ② Press button C to stop the stopwatch.
- ③ Press button D to reset the stopwatch.

[The time of the 2nd competitor measured in “Measurement of two competitors.”]

- ① Press button D. The stopwatch hands move quickly and stop.
- ② Press button D to reset the stopwatch.

\* The stopwatch hour hand returns to the display of charging status after the reset.

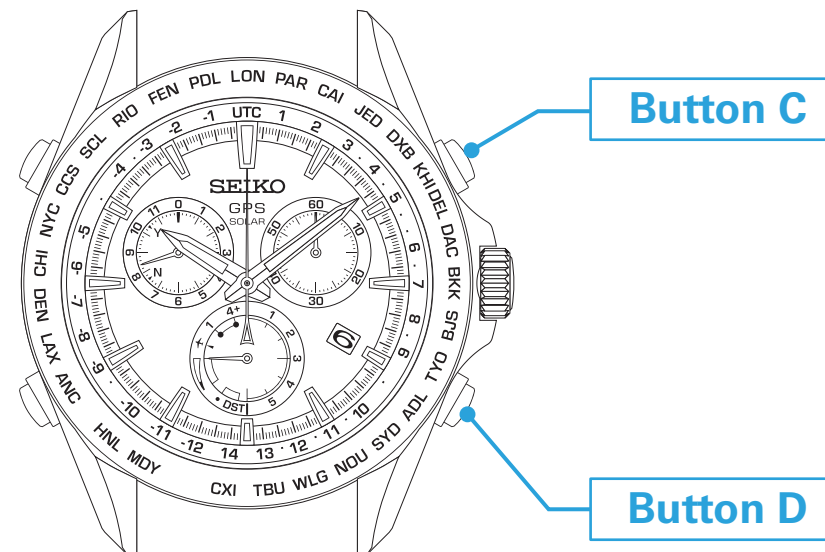

## How to Use the Tachymeter

Speed per hour and production volume per hour, etc., can be easily measured by using the tachymeter.

Measurement of speed per hour

- ① The time required to run 1 km can be measured (when the time required is less than 60 seconds).
- ② Check the numerals on the tachymeter scale to which the stopwatch 1/5-second hand is pointing.

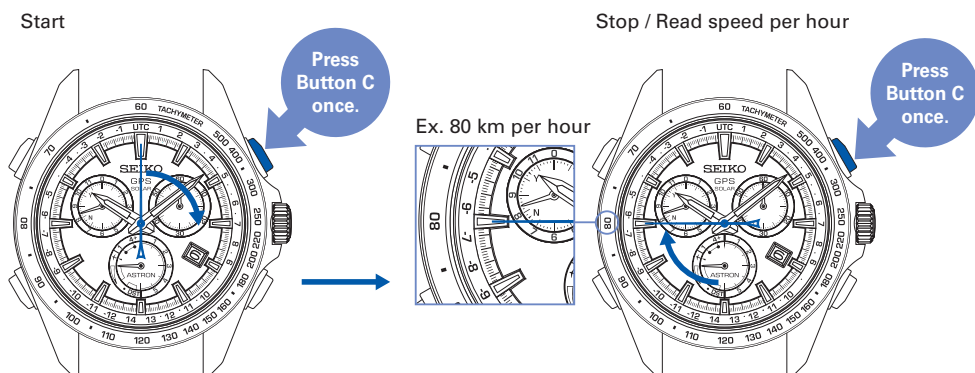

Production volume per hour

- ① The time required to make one product can be measured (when the time required is less than 60 seconds).
- ② Read the numerals on the tachymeter scale to which the stopwatch 1/5-second hand is pointing.

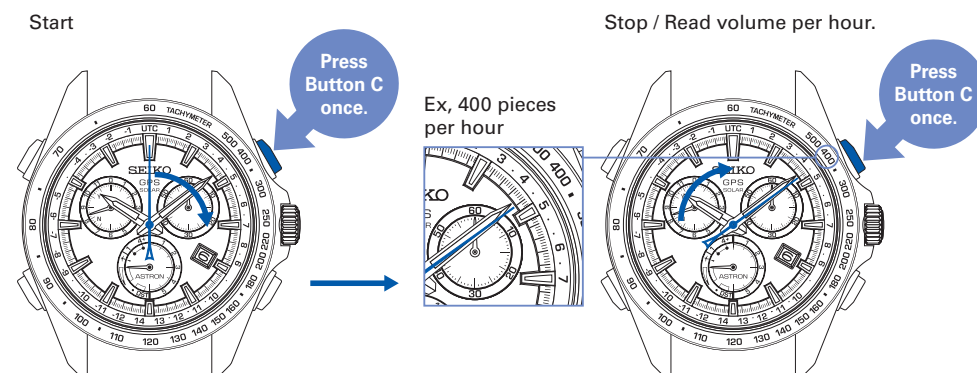



## Small second hand movement and watch state (energy depletion forewarning function)

Movement of the small second hand shows the state of the watch (working functions).

■ 2-second interval movement/5-second interval movement are brought about

When the energy stored in the watch runs low, the energy depletion forewarning function will work.

When the energy stored in the watch runs low, charge the watch by expose to light. → How to charge the watch P. 14

\* When the energy depletion forewarning function works, the watch does not operate even with operation of the buttons and crown.  
(Be assured that it does not mean a failure)

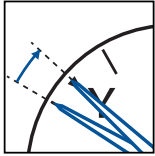
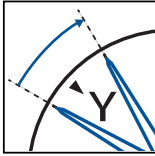
	2-second interval movement	5-second interval movement
State	<p>The small second hand moves at 2-second intervals.</p> 	<p>The small second hand moves at 5-second intervals.</p> 
Restriction on function/display	<ul style="list-style-type: none"> <li>• Reception is not started even with operation of GPS signal reception.</li> <li>• Automatic time adjustment does not work.</li> <li>• Stopwatch function does not work.</li> </ul>	<ul style="list-style-type: none"> <li>• The hour hand, minute hand, date, and sub-dial stop.</li> <li>• Reception is not started even with operation of GPS signal reception.</li> <li>• Automatic time adjustment does not work.</li> <li>• Stopwatch function does not work.</li> </ul>
Solution	<p>(1) First, charge the watch by expose to light until the small second hand moves at 1-second intervals. → <b>How to charge the watch P. 14</b></p> <p>(2) Keep in mind to charge the watch until the indicator hand points to the middle position or full position. (If the indicator hand points to low position, GPS signals cannot be received.) → <b>Check the charging status P. 13</b></p>	<p>(1) Charge the watch until the indicator hand points to the middle position or full position. → <b>Check the charging status P. 13</b></p> <p>(2) Carry out time zone adjustment to set the time. → <b>How to adjust the time zone P. 18</b></p>

Continued on the following page

## □ The small second hand stops at the 15-second position/ 45-second position (Power save function)

When the watch is not exposed to light for a long time, the power save function will work.

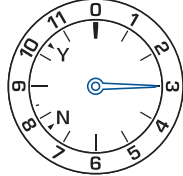
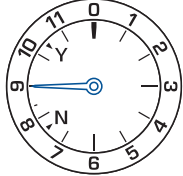
	Power Save 1	Power Save 2
State	The small second hand stops pointing at the 15-second position. 	The small second hand stops pointing at the 45-second position. 
Restriction on function/display	<ul style="list-style-type: none"> <li>• The hour hand, minute hand and date stop.</li> <li>• Automatic time adjustment is not performed.</li> </ul>	<ul style="list-style-type: none"> <li>• The hour hand, minute hand and date stop. (Date displays "1")</li> <li>• Reception is not started even with operation of GPS signal reception.</li> <li>• Automatic time adjustment is not performed.</li> <li>• The indicator hand points to low position.</li> <li>• Stopwatch function does not work.</li> </ul>
Cause	When the watch is exposed to a state without receiving an adequate light source for 72 hours or longer.	When the watch is in an insufficient charging state for a long time.
Solution	When the watch is exposed to an adequate light source for more than 5 seconds, or when any button is pressed, it displays the current time again after the small second hand is rapidly advanced.	(1) Charge the watch sufficiently until the charging status is displayed as the middle position or full position. → <a href="#">P. 13 ~ 14</a> (2) Carry out time zone adjustment to set the time. → <a href="#">P. 17 ~ 18</a>

### Power Save 2

- \* While the watch is being charged, the small second hand moves at "5-second intervals." During the "5-second Interval Movement," the buttons cannot be operated.
- \* If the "Power Save 2" mode is prolonged, the stored power amount drops and the internal current time information stored will be lost.



## Daily care

### ● The watch requires good daily care

- Do not wash the watch when its crown is at the extended position.
- Wipe away moisture, sweat or dirt with a soft cloth
- After soaking the watch in seawater, be sure to wash the watch in clean pure water and wipe it dry carefully.

\* If your watch is rated as “non-water resistant” or “water resistant for daily use,” do not wash the watch.

**Performance and caliber / case number** → P. 36

**Water resistance** → P. 37

### ● Turn the crown from time to time

- In order to prevent corrosion of the crown, turn the crown from time to time.

### ● Press the buttons once in a while.

- Press the buttons once in a while to prevent corrosion of the buttons.
- \* Be aware that you may activate the stopwatch or other function by pressing the buttons.

## Performance and caliber / case number

The case back shows the performance and caliber / case number of your watch

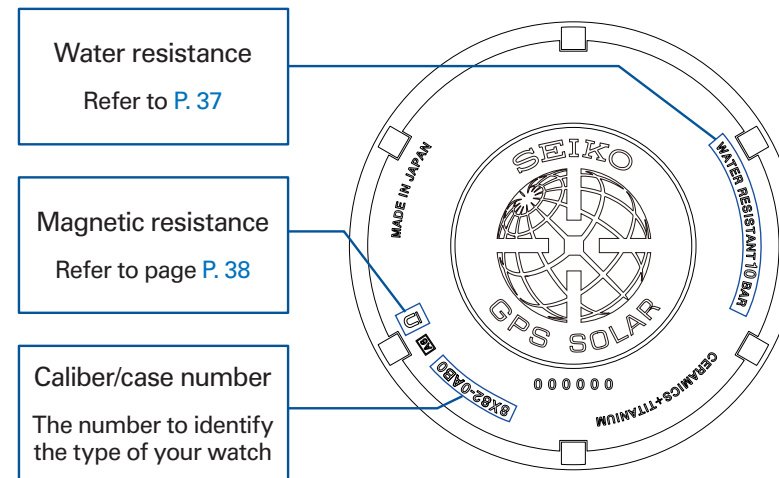

\* The above figures are examples. Both of them may be different from the figure on the case back of your watch.

---

## Water resistance

---

Refer to the table below for the description of each degree of water resistant performance of your watch before using.

Indication on the case back	Water resistant performance	Conditions of Use
Water Resistant 10 (20) Bar	Water resistance for everyday life at 10 (20) barometric pressures	The watch is suitable for diving without an air cylinder.

## Magnetic resistance (Magnetic influence)

**This watch may be affected by nearby magnetism and temporarily gain or lose time or stop operating.**

\* Even when the watch gains or loses time due to magnetic influence, the hand positions are automatically adjusted by the "automatic hand position adjustment function." (P. 46)

This watch has magnetic resistance which complies with ISO "Magnetic resistant watches".

**Caution**

Keep the watch more than 5cm away from magnetic products.

If the watch becomes magnetized and its accuracy deteriorates to an extent exceeding the specified rate under normal use, there will be a charge for demagnetization and accuracy readjustment even if it occurs within the guarantee period.

**The reason why this watch is affected by magnetism**

The built-in motor is provided with a magnet, which may be influenced by a strong external magnetic field.

**Examples of common magnetic products that may affect watches**

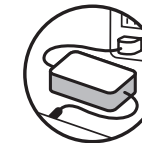
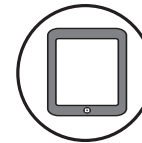

Smartphone, cellular phone, tablet terminal (speaker)

AC adapter

Bag (with magnet buckle)

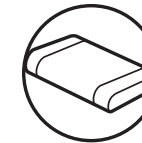
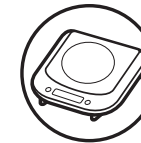

AC-powered shaver

Magnetic cooking device

Portable radio (speaker)

Magnetic necklace

Magnetic heat pillow

## Band

The band touches the skin directly and becomes dirty with sweat or dust. Therefore, lack of care may accelerate deterioration of the band or cause skin irritation or stain on the sleeve edge. The watch requires a lot of attention for long usage.

### ● Metallic band

- Moisture, sweat or soil will cause rust even on a stainless steel band if they are left for a long time.
- Lack of care may cause a yellowish or gold stain on the lower sleeve edge of shirts.
- Wipe off moisture, sweat or soil with a soft cloth as soon as possible.
- To clean the soil around the joint gaps of the band, wipe it out in water and then brush it off with a soft toothbrush (Protect the watch body from water splashes by wrapping it up in plastic wrap etc.)
- Because some titanium bracelets use pins made of stainless steel, which has outstanding strength, rust may form in the stainless steel parts.
- If rust advances, pins may poke out or drop out, and the watch case may fall off the bracelet, or the clasp may not open.
- If a pin is poking out, personal injury may result. In such a case, refrain from using the watch and request repair.

### ● Leather band

- A leather band is susceptible to discoloration and deterioration from moisture, sweat and direct sunlight.
- Wipe off moisture and sweat as soon as possible by gently blotting them up with a dry cloth.
- Do not expose the watch to direct sunlight for a long time.
- Please take care when wearing a watch with light-colored band, as dirt is likely to show up.
- Refrain from wearing a leather band watch other than Aqua Free bands while bathing, swimming, and when working with water even if the watch itself is water-resistant enforced for daily use (10-BAR/20-BAR water resistant).

### ● Polyurethane band

- A polyurethane band is susceptible to discoloration from light, and may be deteriorated by solvent or atmospheric humidity.
- A translucent, white, or pale colored band easily adsorbs other colors, resulting in color smears or discoloration.
- Wash out dirt in water and clean it off with a dry cloth. (Protect the watch body from water splashes by wrapping it up in plastic wrap etc.)
- When the band becomes less flexible, have the band replaced with a new one. If you continue to use the band as it is, the band may develop cracks or become brittle over time.

### ● Silicone band

- As for material characteristics, the band is easily dirtied, and may be stained and discolored. Wipe off dirt with a wet cloth or cleaning tissue.
- Unlike bands of other materials, cracks may result in the band being cut. Take care not to damage the band with an edged tool.

Notes on skin irritation and allergy	Skin irritation caused by a band has various reasons such as allergy to metals or leathers, or skin reactions against friction on dust or the band itself.
Notes on the length of the band	Adjust the band to allow a little clearance with your wrist to ensure proper airflow. When wearing the watch, leave enough room to insert a finger between the band and your wrist. 

## How to use an adjustable three-fold clasp

Some bands are provided with an adjustable three-fold clasp. If the clasp of the watch you purchased is as follows, please refer to the following instructions.

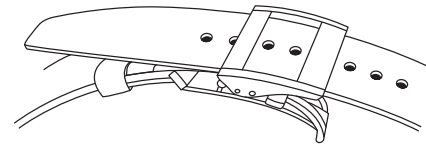

### ● How to wear or take off the watch

- 1 Press the button on both sides of the flap ; pull the buckle up. The band will automatically come out of the loop.
- 2 Place the tip of the band into the moveable loop and fixed loop, and fasten the clasp by pressing the frame of the buckle.

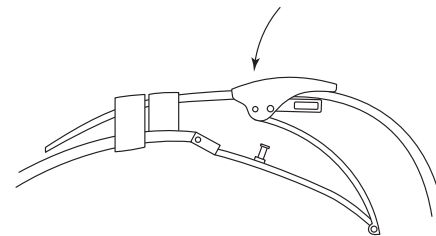
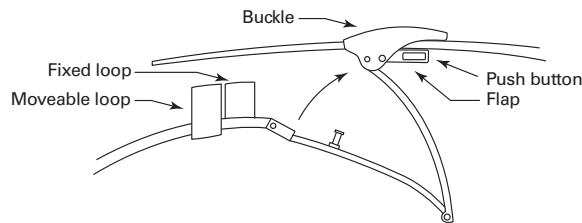

### ● How to adjust the length of the leather band

- 1 With pressing buttons on both sides of the flap, pull the leather band out of the moveable loop and fixed loop.
- 2 Press the push buttons again to unfasten the flap.

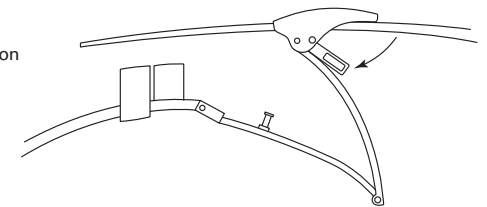
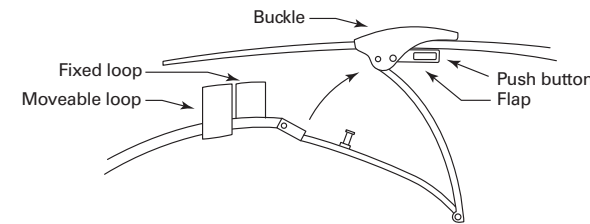

- 3 Pull the pin out of an adjustment hole of the band. Slide the band to adjust its length and find an appropriate hole. Place the pin into the hole.
- 4 Fasten the flap.

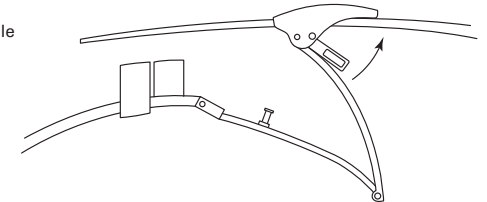
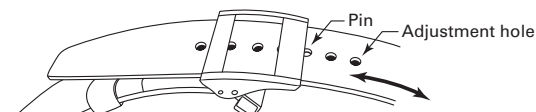

\* The above illustrations are provided as examples. Some details may differ depending on the model.

## Lumibrite

### If your watch has Lumibrite

Lumibrite is a luminous paint that is completely harmless to human beings and natural environment, containing no noxious materials such as radioactive substance. Lumibrite is a newly-developed luminous paint that absorbs the light energy of the sunlight and lighting apparatus in a short time and stores it to emit light in the dark. For example, if exposed to a light of more than 500 lux for approximately 10 minutes, Lumibrite can emit light for 3 to 5 hours. Please note, however, that, as Lumibrite emits the light it stores, the luminance level of the light decreases gradually over time. The duration of the emitted light may also differ slightly depending on such factors as the brightness of the place where the watch is exposed to light and the distance from the light source to the watch.

\* In general, when you enter a dark place from a bright environment, your eye cannot adapt to the change in light levels quickly. At first, you can hardly see anything, but as time passes, your vision gradually improves. (Dark adaptation of the human eye)

< Reference data on the luminance >

Condition		Illumination
Sunlight	Fine weather	100,000 lux
	Cloudy weather	10,000 lux
Indoor (Window-side during daytime)	Fine weather	more than 3,000 lux
	Cloudy weather	1,000 to 3,000 lux
	Rainy weather	less than 1,000 lux
Lighting apparatus (Distance from 40-watt daylight fluorescent light)	1 m	1,000 lux
	3 m	500 lux (average room luminance)
	4 m	250 lux

## Power Source

The battery used in this watch is a special secondary battery, which is different from ordinary batteries. Unlike an ordinary silver oxide battery, the secondary battery does not require periodic replacement.

The capacity or charging efficiency may gradually lower due to long-term use or operating environment. In addition, long-term use may shorten the charge duration due to wear, contamination, lubricant deterioration of mechanical parts, etc. Request repair when the performance lowers.

### WARNING

#### Notes on replacing the secondary battery

- Do not remove the secondary battery from the watch. Replacement of the secondary battery requires professional knowledge and skill. Please ask the retailer from whom the watch was purchased for replacement of the secondary battery.
- Installation of an ordinary silver oxide battery can generate heat that can cause bursting and ignition.

#### \* Overcharge prevention function

When the secondary battery is fully charged, the overcharge prevention function is automatically activated to avoid further charging. There is no need to worry about damage caused by overcharging no matter how much the secondary battery is charged in excess of the "time required for fully charging the watch".

\* Refer to "Standard charging time" on page 14 to check the time required for fully charging the watch.

### WARNING

#### Notes on charging the watch

- When charging the watch, do not place the watch in close proximity to an intense light source such as lighting equipment for photography, spotlights or incandescent lights, as the watch may be excessively heated resulting in damage to its internal parts.
- When charging the watch by exposure to direct sunlight, avoid places that easily reach high temperatures, such as a car dashboard.
- Always keep the watch temperature under 60°C (140 °F).

#### \* When the watch has not been charged for a long time

If the watch has not been charged for a long time, the watch will be completely discharged and no longer able to be charged. In this case, consult the retailer from whom the watch was purchased.



---

## After-sale service

---

### ● Notes on guarantee and repair

- Contact the retailer from whom the watch was purchased or SEIKO WORLDWIDE SERVICE NETWORK for repair or overhaul.
- Within the guarantee period, present the certificate of guarantee to receive repair services.
- Guarantee coverage is provided in the certificate of guarantee. Read carefully and retain it.
- For repair services after the guarantee period has expired, if the functions of the watch can be restored by repair work, we will undertake repair services upon request and payment.

### ● Replacement parts

- Please keep in mind that if original parts are not available, they may be replaced with substitutes whose outward appearance may differ from the originals.

### ● Inspection and adjustment by disassembly and cleaning (overhaul)

- Periodic inspection and adjustment by disassembly and cleaning (overhaul) is recommended approximately once every 3 to 4 years in order to maintain optimal performance of the watch for a long time. According to use conditions, the oil retaining condition of your watch mechanical parts may deteriorate, abrasion of the parts may occur due to contamination of oil, which may ultimately lead the watch itself to stop. As the parts such as gasket may deteriorate, water-resistant performance may be impaired due to intrusion of perspiration and moisture. Please contact the retailer from whom the watch was purchased for inspection and adjustment by disassembly and cleaning (overhaul). For replacement of parts, please specify "SEIKO GENUINE PARTS." When asking for inspection and adjustment by disassembly and cleaning (overhaul), make sure that the gasket and push pin are also replaced with new ones.
- When your watch is inspected and adjusted by disassembly and cleaning (overhauled), the movement of your watch may be replaced.



## When the watch is unable to receive GPS signals

### □ Points to be checked

When the watch does not start receiving or is unable to receive GPS signals even with operation of GPS signal reception, the following can be considered.

#### ● Reception is not started even with operation of GPS signal reception (time zone adjustment/manual time adjustment).

- Check the indicator hand position.

Reception is not allowed	Indicator display	Charging status	In-flight mode (✂)
		low	
Display			
Solution	Charge the watch by exposure to light until the indicator hand points to the middle position or full position. (P. 14)	Reset the in-flight mode (✂). → P. 21	

- Check that the stopwatch is not moving.

#### ● Reception is not possible even with operation of GPS signal reception (time zone adjustment/manual time adjustment) (The reception result is displayed as "N.")

- Move to a place where GPS signals can be easily received.

→ Place where GPS signals can be easily received/Place where GPS signals cannot be received P. 16

#### ● The second hand stops at the 45-second position before the reception is completed (The watch enters the power save 2 state)

- If GPS signal reception is performed under low temperatures (0°C or less) in a state where the charging capacity and/or charging efficiency are lowered, the reception will be stopped, and the watch may enter the power save 2 state.

GPS signal reception consumes a significant amount of energy. Keep in mind to charge the watch regularly by exposure to light.

→How to charge the watch P. 14

If this occurs frequently, consult the retailer from whom the watch was purchased.

### Adjust the time under a condition in which the watch is unable to receive GPS signals (Manual time setting)

#### □ Manual time setting

When a problem cannot be solved even by carrying out the "□ Points to be checked," or time is gained or lost under a condition in which the watch is unable to receive GPS signals and the watch is unable to receive GPS signals continuously, set the time manually.

Continued on the following page

## How to manually set the time

- When using the watch again under a condition in which the watch is able to receive GPS signals, receive GPS signals to set the time.
- When adjusting the time, the date will also be adjusted.

### 1 Pull out the crown to the second click

The small second hand stops at that place.

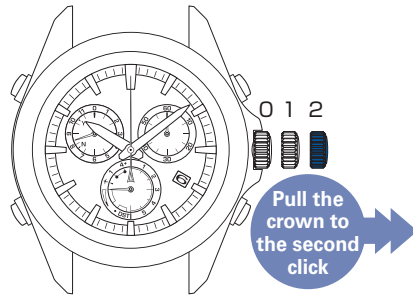

\* If the stopwatch is being used, it will be reset.

### 2 Press Button A and then release it

The second hand moves to stop at the 0-second position.

The watch enters the manual time setting mode.

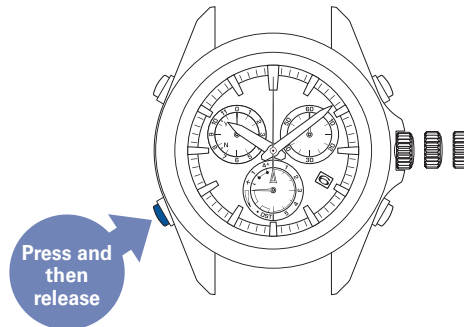

\* When the watch enters the manual time setting mode, the reception result will be displayed as "N," since the reception results data will be lost.

### 3 Turn the crown to set the time

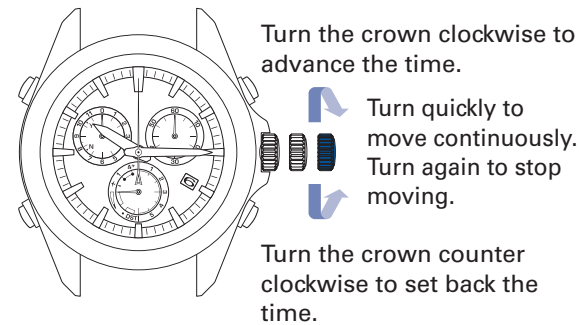

- \* When it has moved continuously for 12 hours, it will stop. Turn the crown to continue setting.
- \* The point in which the date changes is at 0:00 AM (12:00 PM). Set the time taking into consideration AM or PM.

### 4 Push the crown back in (simultaneously with a time signal)

Operation has been completed. The watch resumes its normal movement.

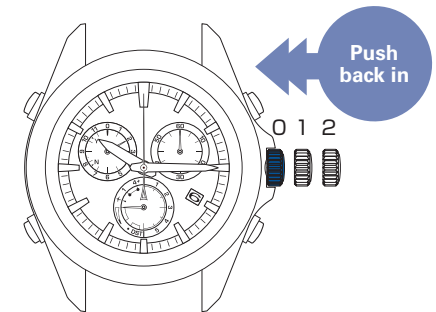

- \* Even if GPS signals cannot be received, the watch can be used with the same accuracy as a normal quartz watch. (at loss/gain  $\pm 15$  seconds per month on average)
- \* If the watch receives GPS signals after manual time setting, it displays the received time.

## When the stopwatch hand, date or indicator hand position is misaligned

### □ Points to be checked

- Reception was successful (the reception result is displayed as "Y"), but time has gained or lost.

- Check the time zone setting.

→ Check the time zone setting and DST (Daylight Saving Time) setting. [P. 20](#)

If the currently set time zone does not correspond to the region where you are, set the time zone by either of the following operations.

Place where GPS signals can be easily received → [How to adjust the time zone P. 18](#)

Place where GPS signals cannot be received → [How to manually set the time zone P. 22](#)

- Check DST (Daylight Saving Time) setting.

→ Check the time zone setting and DST (Daylight Saving Time) setting [P. 20](#)

If DST (Daylight Saving Time) setting does not correspond to the addition conditions of DST (Daylight Saving Time) of the region where you are, set DST (Daylight Saving Time) with reference to "Set DST (Daylight Saving Time) [P. 19](#)."

- Automatic time adjustment function may not have been activated for a few days.

→ Automatic time adjustment [P. 25](#)

The automatic time adjustment function is unlikely to be activated due to low energy stored in the watch or depending on the environment.

To immediately adjust the time, refer to "How to adjust the time zone [P. 18](#)."

### □ Preliminary position

When the watch is unable to display the precise time or date, or any stopwatch hands or indicator hand does not point to the correct position even when it has successfully received GPS signals, the preliminary position may be misaligned.

The preliminary position is misaligned due to the following reasons.



Strong impact such as dropping or hitting

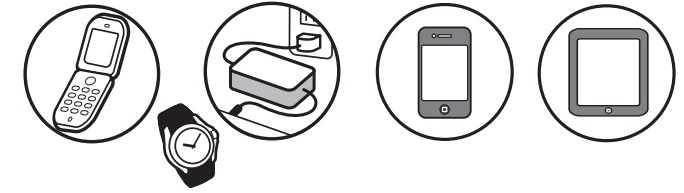

Things around you which generate magnetism  
→ Examples of common magnetic products that may affect watches [P. 38](#)

When comparing the state of "Misaligned Preliminary Hand Position" to that of a weight scale, it is like "a scale which is unable to display the correct weight because its needle is not set to the zero position before weighing."

### □ Adjusting the preliminary position of the hour, minute and small second hands (Automatic hand position adjustment function)

The hour, minute and small second hands have an "automatic hand position adjustment function," which automatically corrects an incorrect preliminary position.

The automatic hand position adjustment function is activated once a minute for the small second hand and at 12:00 both for the AM and PM for the hour and minute hands.

- \* This function works when the preliminary hand position is misaligned due to external factors such as strong impact or magnetic influence. It does not work to adjust accuracy of the watch or slight misalignment which may occur during the manufacturing process.
- \* The preliminary position of the hour and minute hands can be manually adjusted.  
→ [Adjust the preliminary position of the stopwatch hand, date, indicator hand, and hour/minute hands P. 47](#)

### □ Adjusting the preliminary position of the stopwatch hand, date, indicator hand, and hour/minute hands

Since the preliminary position of the stopwatch hand, date, and indicator hand is not automatically adjusted, it must be adjusted manually.

→ [Adjust the preliminary position of the stopwatch hand, date, indicator hand, and hour/minute hands P. 47](#)

## □ Preliminary position of this watch

The preliminary position of the date is "1" (1<sup>st</sup>).

The preliminary position of the indicator hand is "low".

The preliminary position of the hour/minute hands is "12:00 am."

The preliminary position of the stopwatch 1/5-second hand is "0 second".

The preliminary position of the stopwatch minute hand is "0 minute".

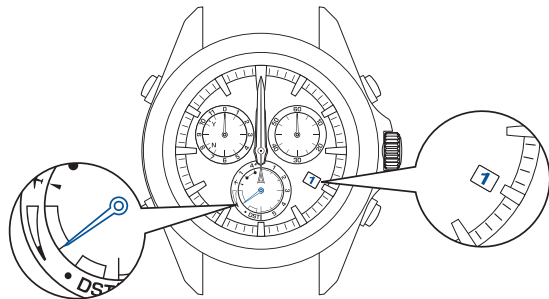

## □ Adjust the preliminary position of the stopwatch hand, date, indicator hand, and hour/minute hands

**1** Pull out the crown to the second click.

The small second hand stops.

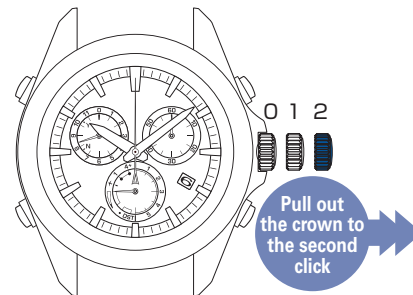

\* When the stopwatch is measuring, the stopwatch will be automatically reset.

**2** Continue to press Button C (three seconds).

The watch enters the mode to adjust the preliminary position of the stopwatch 1/5-second hand.

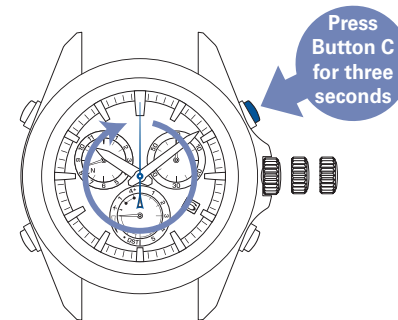

The stopwatch 1/5-second hand makes one complete turn and stops.

**3** Turn the crown to set the stopwatch 1/5-second hand pointing to the "0-second" position.



Turn the crown clockwise to advance 1 step.

Turn the crown quickly to move it continuously.  
Turn the crown again to stop.

Turn the crown counterclockwise to set back 1 step.

Continued on the following page

## 4 Press Button C and then release it.

The watch enters the mode to adjust the preliminary position of the stopwatch minute hand.

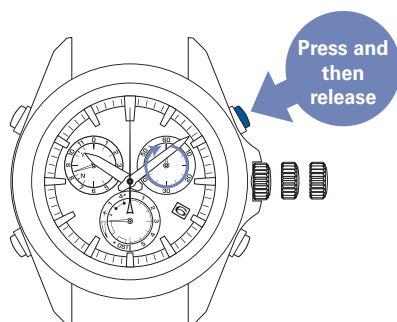

The stopwatch minute hand makes one complete turn and stops.

## 5 Turn the crown to set the stopwatch minute hand pointing to the "0-minute" position.

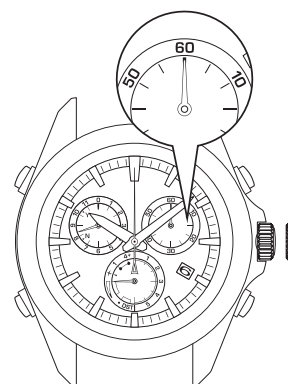

Turn the crown clockwise to advance 1 step.

Turn the crown quickly to move it continuously.  
Turn the crown again to stop.

Turn the crown counterclockwise to set back 1 step.

Continued on the following page

6 Continue to press Button B (three seconds).

The watch enters the mode to adjust the preliminary position of the date.

Press Button B for three seconds



\* During movement of the date, the buttons cannot be operated.

The small second hand stops at the 18-second position.



7 Rotate the crown to set the date to "1."

Adjust the date so that the position of "1" will locate at the center of the window.

\* If "1" is displayed, go to operation of ⑧.

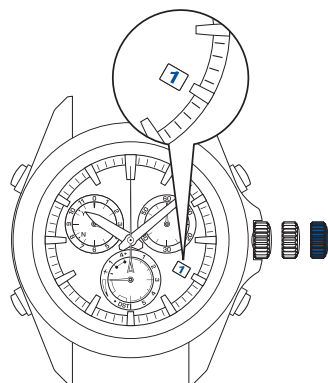

Turn the crown clockwise to advance 1 step.

Turn the crown quickly to move it continuously. Turn the crown again to stop.

Turn the crown counterclockwise to set back 1 step.

8 Press Button B and then release it.

The watch enters the mode to adjust the preliminary position of the indicator hand.

Press and then release



The small second hand stops at the 38-second position.



Continued on the following page



## 9 Rotate the crown to adjust the indicator hand as shown in the figure.

Adjust the indicator hand to the position as shown in the figure.

\* If the indicator hand points as shown in the figure, go to operation of ⑩.

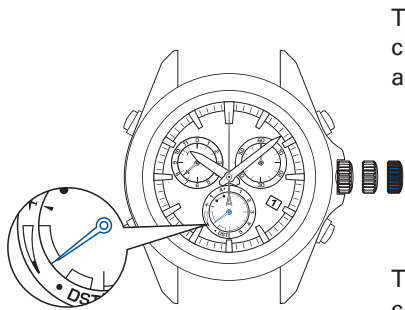

Turn the crown clockwise to advance 1 step.

Turn the crown quickly to move it continuously. Turn the crown again to stop.

Turn the crown counterclockwise to set back 1 step.

\* The indicator hand makes one complete turn, but this does not mean a failure.

## 10 Press Button B and then release it.

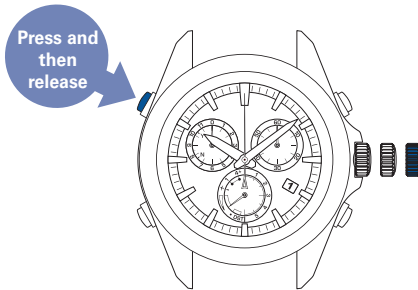

The small second hand stops at the 0-second position.

## 11 Continue to press Button A (three seconds).

The hour/minute hands move, and stop at "12:00 am."

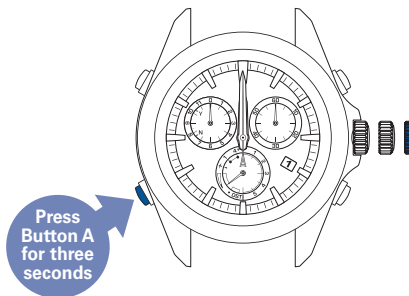

## 12 Push the crown back in.

The watch exits the mode to adjust the preliminary position, and the small second hand and the hour/minute hands start moving.

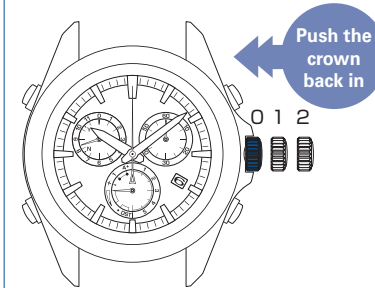

## 13 Set the time by receiving GPS signals.

When you are in a place where GPS signals can be easily received, adjust the time zone.

→ [How to adjust the time zone P. 18](#)

After operation of ① to ⑫ is completed, make sure to set the time.

When you are in a place where GPS signals cannot be received

- ① Carry out manual time zone setting  
→ [How to manually set the time zone P.22](#)
- ② Manually set the time  
→ [How to manually set the time P.45](#)

**When the time is set, operation is completed.**

## Cancel the light detection

### ■ Cancel the setting of light detection

The light detection can be cancelled.

While the light detection is disabled, the automatic time adjustment setting is altered to the fixed time reception setting. In such a case, the watch stores the time of the previously successful manual time adjustment, and automatically starts time adjustment at the same time.

\* The light detection is turned on by default.

**1** Continue to press Button A and Button B simultaneously (three seconds).

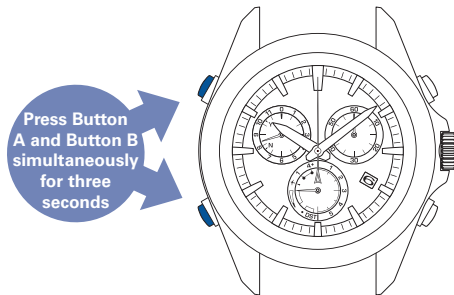

**2** Continue to press Button B (three seconds).

“ON” or “OFF” of light detection can be selected.  
The small second hand that has pointed to Y (52-second position: ON) turns to point to N (38-second position: OFF).

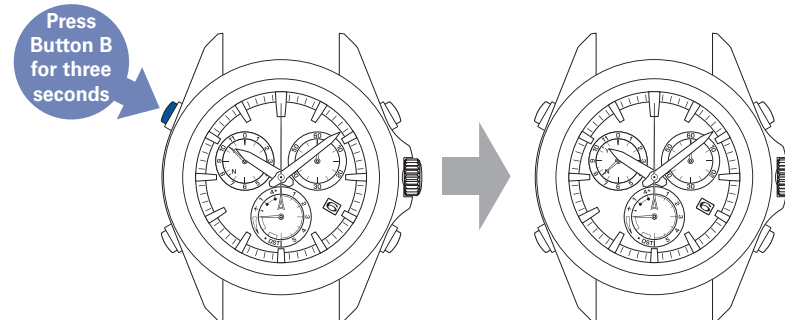

**3** Press Button A.

The watch returns to the time display mode.

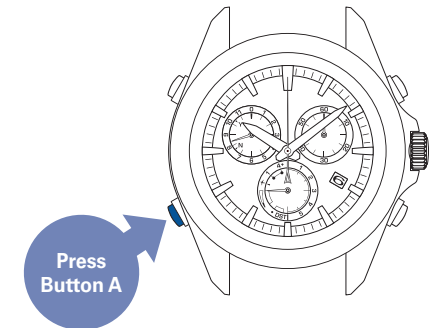



### ■ How to turn the light detection on

Perform the operations ① to ③ to turn the light detection on.

Adjust the small second hand to point to Y (52-second position: ON) in the operation ②.

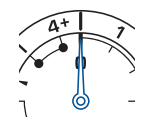
## Troubleshooting

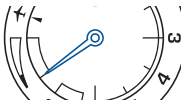
At trouble		Possible causes	Solutions	Reference pages
<b>Hand Movement</b>	The small second hand moves at 2-second intervals.	The energy depletion forewarning function is activated. (P. 34) If the second hand moves at 2 or 5-second intervals while you wear the watch everyday, the watch is in a condition where it cannot acquire sufficient light, for instance, the watch is concealed under a long sleeve shirt.	Charge the watch sufficiently until the second hand moves at 1-second intervals and the indicator hand points to the middle position or full position.  middle position	P. 13 P. 14
	The small second hand moves at 5-second intervals.			
	The stopped small second hand pointing to the 15-second position started operating.	The power save function 1 has been activated (P. 35) When the watch has not been exposed to sufficient light continuously, the power save function 1 to limit energy consumption is automatically activated.	When the watch is exposed to light, the hand will rapidly advance and return to the current time. When the watch returns to the current time, use it as is. (This is not an abnormal movement.)	—
	The stopped small second hand pointing to the 45-second position started operating.	The power save function 2 has been activated (P. 35) When the watch is not sufficiently charged for a certain period of time, the power save function 2 is automatically activated.	① Charge the watch until the indicator hand points to the middle position or full position. ② After that, when the time is incorrect, adjust the time zone as necessary.	P. 13 P. 14 P. 17 ~ 18
	The watch hands advance rapidly unless a button is pressed. After the rapid advancement is completed, the watch resumes its normal 1-second interval movement.	The power save function has been activated. (P. 35) The automatic hand position alignment function was activated. When the hand positions deviate to display incorrect time as a result of external influences, etc., the watch automatically corrects the hand misalignment by the automatic hand position alignment function.	No operation is needed (this is not an abnormal movement).	—
	Although the stopwatch function is not being used, the indicator hand is pointing to 0 (zero).	The automatic leap second reception function has been activated (P. 27)	 It takes up to 18 minutes to complete reception. Use the watch with reference to the "Place where GPS signals can be easily received P. 16."	P. 27

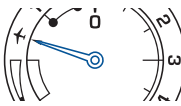
At trouble		Possible causes	Solutions	Reference pages
GPS signal reception	Reception is not started even with operation of time zone adjustment/manual time adjustment	The charging status has been displayed as low position. (P. 13) 	Charge the watch sufficiently until the charging status is displayed as the middle position or full position.  middle position	P. 14
		The in-flight mode (✈) has been set. (P. 21) 	After relocation from a place under restriction on use of GPS signals (in an airplane, etc.), reset the in-flight mode (✈).	P. 21
		The stopwatch hands are moving. The stopwatch has not been reset.	Stop and reset the stopwatch.	P. 32
	GPS signals cannot be received even by carrying out GPS signal reception (The reception result is displayed as "N.")	You are in a place where GPS signals cannot be received. (P. 16)	Receive GPS signals in a place where GPS signals can be easily received.	P. 16
	GPS signals have been received successfully (the reception result is displayed as "Y") but the time and date are gained or lost (when the reception result of time adjustment is displayed)	The time zone that does not correspond to the region where you are has been set.	Check the time zone setting. If the time zone does not correspond to the region where you are, adjust the time zone. • When you are in a place where GPS signals can be easily received → How to adjust the time zone • When you are in a place where GPS signals cannot be received → How to manually set the time zone	P. 20 P. 18 P. 22
		DST (Daylight Saving Time) setting does not correspond to the addition conditions of DST (Daylight Saving Time).	Check DST (Daylight Saving Time) setting.	P. 20

At trouble		Possible causes	Solutions	Reference pages
GPS signal reception		DST (Daylight Saving Time) setting does not correspond to the addition conditions of DST (Daylight Saving Time).	Check DST (Daylight Saving Time) setting.	P. 20
	The reception result is displayed as "Y," but the time and date are gained or lost (when the reception result of time zone adjustment is displayed)	The position of the hands is misaligned due to external factors. The preliminary position of the hands is misaligned. → Preliminary position P. 46	① <Hour/minute hand misalignment> The automatic hand position adjustment function is activated to automatically adjust the positions. Please use the watch as it is. The automatic hand position alignment function is activated once a minute for the second hand and at 12:00 AM and PM for the hour and minute hands. <Date misalignment> Since the preliminary position is not automatically adjusted, manually adjust the position. ② When misalignment of the hand is not adjusted, refer to the "Adjust the preliminary position of the stopwatch hand, date, indicator hand, and hour/minute hands" to carry out operation. ③ When misalignment of the hand is not adjusted even with operation of ②, consult the retailer from whom the watch was purchased.	P. 47  P. 47
	The reception result is displayed as "Y," but the time is gained or lost by one to two seconds.	The automatic time adjustment function has not been activated for a few days.	If the energy stored in the watch is insufficient, the automatic time adjustment function may be activated once in 3 days.	P. 25
	The automatic time adjustment function is not activated every day	Conditions to activate the automatic time adjustment function are not prepared.	Sufficient energy is necessary to activate the automatic time adjustment function. The time adjustment function is automatically activated by exposure to bright light.	P. 25
	Automatic reception is not activated.	The watch is not in an environment where GPS signals can be received at the moment when light is exposed.	Cancel the function that reception is automatically started by light so that the watch only carries out the fixed time reception. The fixed time in this case means the last time when manual time adjustment was successful. <How to turn the automatic light reception function on or off> 1. Continue to press Buttons A and B simultaneously (3 seconds) The small second hand indicates ON or OFF of the function, Y (52-second position: ON) and N (38-second position: OFF). 2. Continue to press Button B (3 seconds) to turn the function on/off.	P. 51

At trouble		Possible causes	Solutions	Reference pages
<b>Misalignment of time and hands</b>	The position of the small second hand showing "reception result" and "number of acquired satellites from which GPS signals are received" is misaligned.	The preliminary position of the small second hand is misaligned. (This occurs when the position of the small second hand is misaligned due to external factors.) → Preliminary position <a href="#">P. 46</a>	<ul style="list-style-type: none"> <li>① The automatic hand position alignment function is activated to automatically adjust the position. Please use the watch as it is. The automatic hand position alignment function is activated once a minute for the second hand.</li> <li>② When misalignment of the hand is not adjusted, refer to "Adjust the preliminary position of the stopwatch hand, date, indicator hand, and hour/minute hands" to carry out operation.</li> <li>③ When misalignment of the hand is not adjusted even with operation of ②, consult the retailer from whom the watch was purchased.</li> </ul>	<a href="#">P. 46</a> <a href="#">P. 47 ~ 50</a>
	The watch temporarily gains or loses time.	The automatic time adjustment function has not been activated for a few days.	If the energy stored in the watch is insufficient, the automatic time adjustment function may be activated once in 3 days. To adjust the time immediately, carry out "manual time adjustment."	<a href="#">P. 25</a> <a href="#">P. 24</a>
		The watch received an incorrect time due to external factors (erroneous reception).	<ul style="list-style-type: none"> <li>① Receive GPS signals in a place where GPS signals can be more easily received.</li> <li>② Adjust the time zone as necessary.</li> </ul>	<a href="#">P. 16</a> <a href="#">P. 18</a>
		The watch is left in an extremely high or low temperature place for a long time.	<ul style="list-style-type: none"> <li>① If the watch is returned to a normal temperature place, the accuracy will be recovered.</li> <li>② If the time is incorrect after that, manually adjust the time as necessary.</li> <li>③ If the watch is not recovered, consult the retailer from whom the watch was purchased.</li> </ul>	<a href="#">P. 24</a>
The time is gained (lost) 1 hour	DST (Daylight Saving Time) is ON (or OFF).	Check DST (Daylight Saving Time) setting.	<a href="#">P. 20</a>	

At trouble		Possible causes	Solutions	Reference pages
Charging the solar battery	The stopped watch was exposed to an adequate light for longer than the time required to fully charge the watch, however, it does not resume its normal 1-second interval movements.	The amount of exposed light is too weak. The time for charging the watch is not sufficient.	The time required for charging the watch depends entirely on the amount of exposed light the watch receives. Refer to "Standard charging time" to charge the watch.	P. 14
	The small second hand is stopped even when the watch is charged for longer than the time required to fully charge the watch (P. 10).	The watch was not charged for a long time and has been discharged completely.	Contact the retailer from whom the watch was purchased.	—
Misalignment of the date	After successful reception, the time is correct but the date is incorrect	The preliminary position of the date is misaligned. This occurs when the preliminary position of the date is misaligned due to external factors or system reset.	Adjust the preliminary position of the date to the correct position "1" (1st).	P. 47 ~ 50
Misalignment of the stopwatch hands	After resetting the stopwatch, the stopwatch hands do not stop at the 0 position.	The stopwatch hands are out of the preliminary position.	Adjust the preliminary position correctly.	P. 47 ~ 50



At trouble		Possible causes	Solutions	Reference pages
<b>Indicator hand misalignment</b>	The position of the hand showing the reception type, charging status, in-flight mode (✈), and DST is misaligned	The automatic leap second reception function has been activated. (The indicator hand displays as shown at the right.) 	It takes up to 18 minutes to complete the leap second reception. Use the watch with reference to the "Place where GPS signals can be easily received P. 16."	P. 27
		The preliminary position of the indicator hand is misaligned. This occurs when the preliminary position of the indicator hand is misaligned due to external factors.	Adjust the preliminary position of the indicator hand to the correct position.	P. 47 ~ 50
<b>Operation</b>	The crown or buttons cannot be operated.	The stored electric power is running short.	Sufficiently charge the watch until it starts moving at 1-small second intervals.	P. 14
		Date is moving right after a setting is carried out by the crown or button operation.	Wait without doing anything. After the date stops, the crown and buttons can be operated.	—
	You get lost in the middle of the operation.	_____	When the crown is pulled out ① Push the crown back in. ② The second hand will start to move within 6 minutes. ③ After that, restart operation.	—
			When the crown is not pulled out ① Press Button A. ② The second hand will start to move within 2 minutes. ③ After that, restart operation.	—
<b>Other trouble</b>	Blur on the dial glass persists.	Small amount of water has got inside the watch due to deterioration of the gasket, etc.	Contact the retailer from whom the watch was purchased.	—

## Index

### Functions to adjust the time

GPS signal reception → P. 26

Time zone adjustment function ..... This watch can be set to the precise local time by just one button operation\* anywhere in the world.  
→ P. 17

\* DST (Daylight Saving Time) can be set manually.

Use this function when you travel to a region corresponding to another time zone.

Manual time adjustment function ..... Displays the precise current time of the currently set time zone by receiving GPS signals from GPS satellites.  
→ P. 23

Use this function to adjust the time to the precise time during normal use.

Automatic time adjustment ..... Judges inside the watch the timing suitable for GPS signal reception from GPS satellites and automatically starts reception.  
→ P. 25

Displays the precise current time of the currently set time zone.

Manual time zone setting ..... The time zone can be changed manually in a place where the time zone adjustment is not allowed.  
→ P. 22

DST (Daylight Saving Time) setting ..... DST (Daylight Saving Time) can be set manually.  
→ P. 19

### Functions to charge

Solar Charging Function ..... A solar cell underneath the dial converts any form of light into electrical energy to power the watch and the power is stored in a secondary battery.  
→ P. 14

Once fully charged, the watch continues to run for approximately 6 months.

Charging status display function ..... Roughly displays the energy charged in the watch. Also shows whether the watch is able to receive GPS signals.  
→ P. 13

Power Save Function ..... The Power Save mode can be activated in order to reduce unnecessary energy consumption when the watch is left without an adequate light source.  
→ P. 35

## Function for reception

In-flight mode (✈) ..... → P. 21	Function to prevent the GPS signal reception function from working. Set this mode when boarding an airplane, etc.
Satellite acquisition status display function ... → P. 18	Displays by the second hand the number of GPS satellites from which GPS signals are received during GPS signal reception.
Reception result display function ..... → P. 28	Displays the latest reception result (success/failure).
Time zone setting check function ..... → P. 20	Displays the currently set time zone

## Other functions

Stopwatch function ..... → P. 30	Measures up to 6 hours in 1/5 second increments. Split time measurement on demand.
Automatic hand position alignment function ... → P. 45	Automatically corrects misalignment when the hands are misaligned due to external factors such as magnetic influence.
Automatic leap second reception function ... → P. 27	Automatically receives leap second data when leap second data reception is necessary.

## SPECIFICATIONS

1. Basic function ..... Main-dial; three hands (hour/minute/small second hands), date display, indicator hand, stopwatch hands (hour, minute, 1/5 second), world time function
2. Frequency of crystal oscillator ... 32,768 Hz (Hz = Hertz ... Cycles per second)
3. Loss/gain (monthly rate) ..... Loss / gain  $\pm 15$  seconds on a monthly rate (When the watch is used without an automatic time setting by receiving GPS signal and when it is worn on the wrist within a normal temperature range between 5°C and 35°C (41°F and 95°F)).
4. Operational temperature range ... Between -10°C and +60°C (14°F and 140°F)
5. Driving system ..... Step motor (hour/minute/small second hands of main-dial, date, indicator hand, stopwatch hands (hour, minute, 1/5 second))
6. Power source ..... Secondary battery, 1 piece
7. Duration of operation ..... Approximately 6 months (Fully charged, and the Power Save is not activated).  
\* If the Power Save is activated after it is fully charged, the watch continues to run for approximately 2 years at maximum.
8. GPS signal reception function ... Time zone adjustment, manual time adjustment, automatic time adjustment
9. IC (Integrated Circuit) ..... Oscillator, frequency divider and driving circuit C-MOS-IC, 4 pieces

\* The specifications are subject to change without prior notice for product improvement.

Declaration of Conformity

# SEIKO

SEIKO WATCH CORPORATION

## EC Declaration of Conformity

Manufacturer: SEIKO WATCH CORPORATION  
26-1,GINZA 1-CHOME, CHUO-KU,  
TOKYO 104-8118, JAPAN

We declare under our sole responsibility that the following product (s) :

Product Name: GPS Solar Watch

Brand Name: SEIKO

Model Number: 8X22-\*\*\*\*, 8X53-\*\*\*\*, 8X82-\*\*\*\*

“\*” is alphanumeric

to which this declaration relates is in conformity with the provisions of the following directive(s):

R&TTE Directive

DIRECTIVE 1999/5/EC OF THE EUROPEAN PARLIAMENT AND OF THE COUNCIL of 9 March 1999

on radio equipment and telecommunications terminal equipment and the mutual recognition of their conformity

RoHS2 Directive

DIRECTIVE 2011/65/EU OF THE EUROPEAN PARLIAMENT AND OF THE COUNCIL of 8 June 2011

on the restriction of the use of certain hazardous substances in electrical and electronic equipment (recast)

Applied Harmonized Standard(s):

EN 60950-1:2006+Amd.11:2009+Amd.1:2010+Amd.12:2011

EN 301 489-1 V1.9.2:2011-09

EN 301 489-3 V1.4.1:2002-08

EN 300 440-1 V1.6.1:2010-08

EN 300 440-2 V1.4.1:2010-08

EN50581:2012

Technical Documentation is held at the following company:

R&TTE Directive SEIKO WATCH CORPORATION  
26-1,GINZA 1-CHOME, CHUO-KU,  
TOKYO 104-8118, JAPAN

RoHS2 Directive SEIKO EPSON CORPORATION  
3-5,OWA 3-CHOME,SUWA-SHI,  
NAGANO-KEN 392-8502,JAPAN

Place and Date of issue: Tokyo, May 19, 2016

Signature of Responsible Person:



Shunji Tanaka  
Senior Vice President  
Sales Division II